



# 2N<sup>®</sup> Helios Uni

Door Access Intercom



## Installation Manual

Version: 1.0.0

[www.2n.cz](http://www.2n.cz)

The 2N TELEKOMUNIKACE a.s. joint-stock company is a Czech manufacturer and supplier of telecommunications equipment.



The product family developed by 2N TELEKOMUNIKACE a.s. includes intercoms, GSM and UMTS products, private branch exchanges (PBXs) and M2M solution.

2N TELEKOMUNIKACE a.s. has been ranked among the Czech top companies for years and represents a symbol of prosperity in the field of IP intercoms. Furthermore, the company dedicates significant attention to operator solutions as well as to effectively providing support for our distribution network and customer service. At present, we export our products into over 120 countries worldwide and have exclusive distributors on all continents.



2N<sup>®</sup> is a registered trademark of 2N TELEKOMUNIKACE a.s.. Any product and/or other names mentioned herein are registered trademarks and/or trademarks or brands protected by law.



2N TELEKOMUNIKACE administers the FAQ database to help you quickly find information and to answer your questions about 2N products and services. On [faq.2n.cz](http://faq.2n.cz) you can find information regarding products adjustment and instructions for optimum use and procedures „What to do if...“.



#### Declaration of Conformity

2N TELEKOMUNIKACE a.s. hereby declares that the 2N<sup>®</sup> Helios Uni product complies with all basic requirements and other relevant provisions of the 1999/5/EC directive. For the full wording of the Declaration of Conformity see the CD-ROM enclosed and at [www.2n.cz](http://www.2n.cz).



2N TELEKOMUNIKACE company is the owner of the ISO 9001:2008 certificate. All development, production and distribution processes of the company are managed by this standard and guarantee high quality, technical level and professional aspect of all our products.

# Contents

<b>1. Product Overview.....</b>	<b>5</b>
<b>1.1 Product Description .....</b>	<b>6</b>
Basic Features.....	6
Advantages of Use .....	7
<b>1.2 Upgrade .....</b>	<b>8</b>
<b>1.3 2N® Helios Uni Components and Associated Products .....</b>	<b>9</b>
Basic Units.....	9
Mounting Accessories .....	10
GSM / UMTS Connection Accessories .....	10
Electric Locks .....	11
Other Accessories .....	11
<b>1.4 Terms and Symbols .....</b>	<b>12</b>
Symbols.....	12
<b>2. Description and Installation.....</b>	<b>13</b>
<b>2.1 Before You Start .....</b>	<b>14</b>
Product Completeness Check.....	14
<b>2.2 Mechanical Installation .....</b>	<b>15</b>
Mounting Type Overview.....	15
Common Mounting Principles .....	16
Flush Mounting – Classic Bricks .....	17
Flush Mounting – Plasterboard .....	18
Wall Mounting.....	18
<b>2.3 Electric Installation .....</b>	<b>19</b>
PCB Connectors.....	19
Compatibility .....	20
Connection to Telephone Line .....	20
<b>2.4 Button Tags – Insertion, Replacement.....</b>	<b>22</b>
Tag Printing .....	22
Tag Inserting / Replacing .....	22
<b>3. Function and Use .....</b>	<b>23</b>
<b>3.1 Programming .....</b>	<b>24</b>
Entering Programming Mode .....	24
Programming Procedure .....	24
Programming Error.....	25
Deleting All Passwords, All Memories, Complete Initialisation .....	26
If You Forget the Service Password.....	26

<b>3.2</b>	<b>Full Parameter Chart .....</b>	<b>27</b>
	Explanation of Some Parameters.....	31
<b>3.3</b>	<b>Function Description .....</b>	<b>32</b>
	From External User's View (Visitor) .....	32
	From Internal User's View (Survey of Functions).....	33
	Signals Overview.....	34
	Call Termination Options - Summary .....	34
	2N® Helios Uni Statuses and Available Operations .....	35
<b>3.4</b>	<b>Section for Advanced Users .....</b>	<b>36</b>
	Automatic Multiple Number Dialling .....	36
	Survey of Messages.....	39
	Arrival/Departure, Day/Night Modes.....	40
<b>3.5</b>	<b>Maintenance.....</b>	<b>41</b>
	Cleaning .....	41
	Future Tag Replacement, Programming Changes .....	41
<b>4.</b>	<b>Technical Parameters .....</b>	<b>43</b>
4.1	Technical Parameters .....	44
<b>5.</b>	<b>Supplementary Information .....</b>	<b>46</b>
5.1	Directives, Laws and Regulations .....	47
5.2	Troubleshooting .....	48
5.3	General Instructions and Cautions .....	49
	Electric Waste and Used Battery Pack Handling .....	50

# 1

## Product Overview

In this section, we introduce the **2N<sup>®</sup> Helios Uni** product, outline its application options and highlight the advantages following from its use.

Here is what you can find in this section:

- Product Description
- Upgrade
- 2N<sup>®</sup> Helios Uni Components and Associated Products

# 1.1 Product Description

## Basic Features

---

**2N® Helios Uni** is Speakerphone to be connected to an analogue line of any PBX. The **2N® Helios Uni** parameters meet all technical requirements mandatory for devices designed for the PSTN (public switched telephone network) connection.

**2N® Helios Uni** provides improved and feature rich options compared with standard door entry systems, this is because you can make use of functions such as call redirection if not answered, or have a day and night mode set up for automatic redirection of the call for instance after normal working hours.

**2N® Helios Uni** can be provided with 1 or 2 pre-programmed buttons.

**2N® Helios Uni** is equipped with an electric lock switch. You can control the switch during a call, using any telephone set with DTMF dialling.

**2N® Helios Uni** is very easy to install. All you have to do is connect the device to an analogue telephone line. You need any 12V AC/DC power supply to feed the electric lock and name tag backlight.

Use a telephone set for configuring **2N® Helios Uni** via a voice menu.

## Advantages of Use

---

- Additional amplifier for higher volume
- Water resistant (without any additional roof)
- High-quality "marine grade" stainless steel front panel
- Variable mounting options (brick/plasterboard flush mounting, wall mounting)
- No special brick/plasterboard flush mounting accessories needed
- Sensitive microphone and powerful loudspeaker
- Bidirectional communication – acoustic echo cancelling
- Name tags with backlight
- Telephone line supply
- Easy, voice menu based remote programming via telephone
- Detection of all standard tones - hangs up automatically

## 1.2 Upgrade

The manufacturer reserves the right to modify the product in order to improve its qualities.



Version	Changes



## 1.3 2N® Helios Uni Components and Associated Products

### Basic Units

---

	
<b>9153201-E</b> <b>2N® Helios Uni</b> 1 button, analogue	<b>9153202-E</b> <b>2N® Helios Uni</b> 2 buttons, analogue

2N® Helios Uni is designed for outdoor applications and requires no additional roof.

All 2N® Helios Uni units can be flush mounted without requiring any additional accessories. Use the appropriate mounting box (see below) for wall (surface) mounting.

## Mounting Accessories

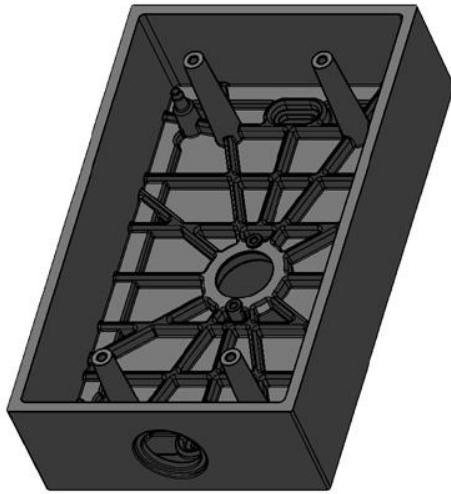

**9153003**  
Wall mounting box  
(Al casting)

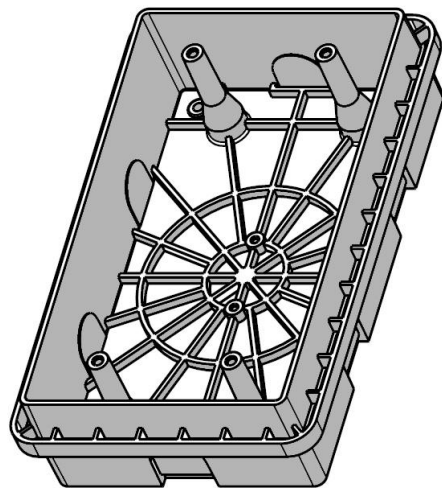

Brick flush mounting box  
(included in the delivery)

## GSM / UMTS Connection Accessories



**GSM gateway EasyGate**  
**501303E**



**GSM gateway EasyGate Pro**  
with battery backup  
**511333E**

## Electric Locks

---



### 932070

BEFO 1211 12V / 600 mA



### 932080

BEFO 1221  
with momentary pin



### 932090

BEFO 1211MB  
with mechanical blocking

## Other Accessories

---



### 91341481E

12 V/2 A adapter  
100 – 240 V / 12 V / 2 A



### 932928E

12 V transformer  
230 V / 12 V



### 9134148E

SIEMENS® Adapter

This is required when connecting to a Siemens HiPath Telephone system

# 1.4 Terms and Symbols

## Symbols

---



### Safety Warning

- **Always** abide by this information to prevent injury of persons!



### Warning

- **Always** abide by this information to prevent damage to the device.



### Caution

- **Important information** for system functionality.



### Tip

- Useful advice.



### Note

- Additional information.

# 2

## Description and Installation

In this section we describe the **2N<sup>®</sup> Helios Uni** product and its installation.

Here is what you can find in this section:

- Before You Start
- Mechanical Installation
- Compatibility
- Electric Installation

## 2.1 Before You Start

### Product Completeness Check

---

Please check the contents of your 2N<sup>®</sup> Helios Uni delivery:

- 1 2N<sup>®</sup> Helios Uni (selected model)
- 1 Torx 10 / Torx 20 double-ended wrench
- 1 2N<sup>®</sup> Helios Uni Installation Manual
- 1 mounting template
- 1 CD
- 1 A5 transparent name plate foil
- 1 spare name plate
- 1 brick flush mounting box
- 4 4x12 stainless steel screws for plastics
- 2 cable ties

## 2.2 Mechanical Installation

### Mounting Type Overview

Refer to the table below for a list of mounting types and necessary components.

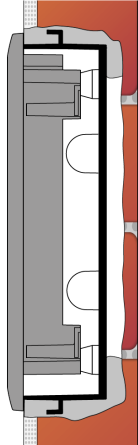
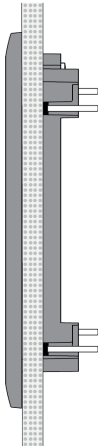
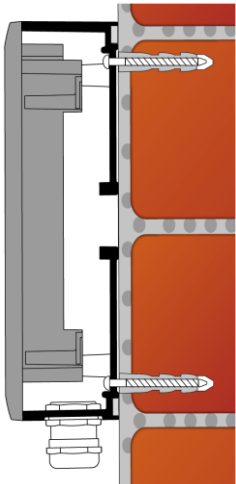
<p><b>Flush mounting – classic bricks</b> (including hollow bricks, thermally insulated walls, etc.)</p> <p><b>What you need:</b> A properly cut hole Plaster, mounting glue, mounting foam or mortar as necessary</p>	
<p><b>Flush mounting – plasterboard</b></p> <p><b>What you need:</b> Just a properly cut hole</p>	
<p><b>Wall mounting</b> (concrete and steel structures, entry barrier columns, etc.)</p> <p><b>What you need:</b> Wall mounting box Part No. <b>9153003</b></p>	

**Caution**

- The warranty does not apply to the product defects and failures arisen as a result of improper mounting (in contradiction herewith). The manufacturer is neither liable for damage caused by theft within an area that is accessible after the attached electric lock is switched. The product is not designed as a burglar protection device except when used in combination with a standard lock, which has the security function.
- When the proper mounting instructions are not met, water might get in and destroy the electronics. It is because the intercom circuits are under continuous voltage and water infiltration causes an electro-chemical reaction. The manufacturer's warranty shall be void for products damaged in this way!

## Common Mounting Principles

---

**Tip**

- Select flush mounting where possible to make your product elegant looking, more vandal resistant and more secure.

**Caution**

- Stainless steel screws are used for the 2N<sup>®</sup> Helios Uni assembly. Other screws than stainless steel ones corrode soon and may aesthetically deteriorate the surrounding environment!
- Having removed the front panel, make sure that no dirt gets inside the product (especially onto the sealing surface).



## Flush Mounting – Classic Bricks

1. Cut a wall hole using the template enclosed. Make sure that all the required cables are available in the hole.
2. Unpack the plastic mounting box. Break out the cable holes as necessary and make sure that the wall hole is big enough for the box.
3. Wall up the mounting box making sure that the box is aligned with the wall surface. Wait until the plaster (mortar, mounting foam, etc.) sets.
4. Unscrew the front panel from the door intercom.
5. Connect the cables to the terminals or RJ connector as described in the **Electric Connection** subsection.
6. You can use the cable tie for connection as shown:

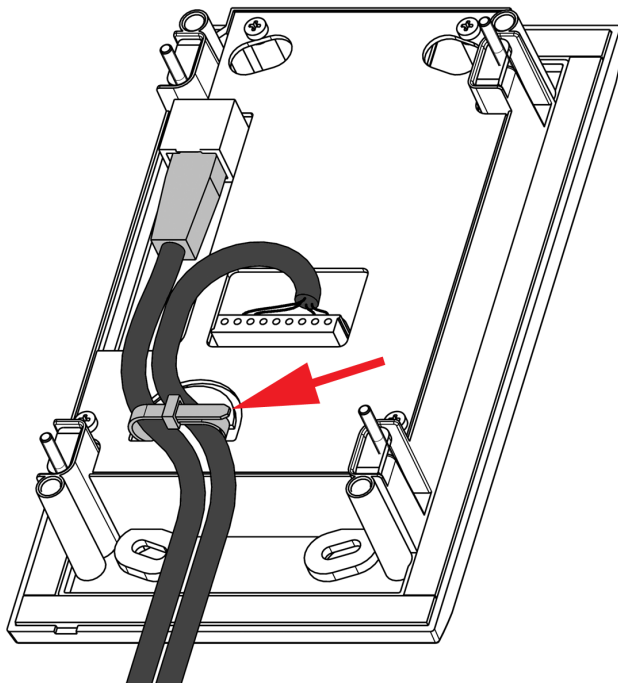

*Suggested cable fixation*

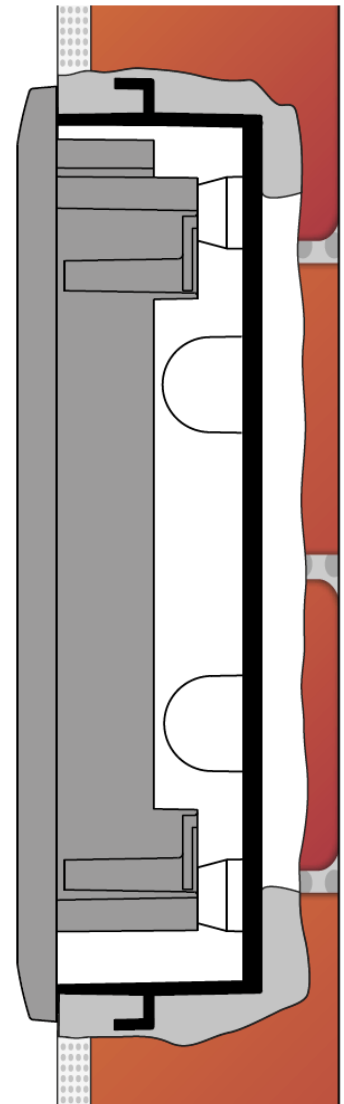

### **Mounting completion – after electric installation!**

7. Insert the intercom in the mounting box in the wall.
8. Tighten the intercom with the stainless steel screws included in the delivery. As the screw holes are oval, you can perfect the vertical position before tightening.
9. We do not recommend you to insert the button tags now.
10. Replace the stainless steel front panel fixing it with the stainless steel screws you unscrewed in step 4 above.

## Flush Mounting – Plasterboard



### Tip

- If this is your first plasterboard installation, check the function of the intercom side clamps. Loosen and then re-tighten the clamp screw to see how it turns automatically and starts moving forwards in its slot. Remember to return the clamp into the original position after the check!

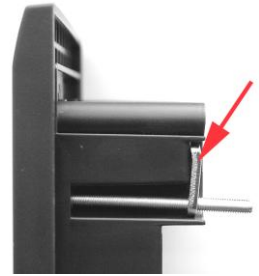

### Caution

- Check the plasterboard wall and room interior pressure values (caused, e.g., by overpressure ventilation). If the difference between the values is too great, separate the intercom using, for example, the mounting box enclosed and seal the cable passage to avoid loudspeaker damage.

1. Cut a hole using the template enclosed (165 x 95 mm).
2. Unscrew the front panel from the door intercom.
3. Connect the cables in the hole to the terminals or RJ connector as described in the **Electric Connection** subsection.
4. You can use the cable tie for connection as shown on previous page.

### Mounting completion – after electric installation!

5. Insert the intercom in the hole keeping it in the vertical position.
6. Loosen the four clamp screws one after another and then retighten them slowly. They will turn aside automatically and start moving forwards in their slots. You need about **10 turns** to tighten the clamps completely. You can perfect the vertical position before final tightening of the screws.
7. We do not recommend you to insert the button tags now.
8. Replace the stainless steel front panel fixing it with the stainless steel screws you unscrewed in step 2.

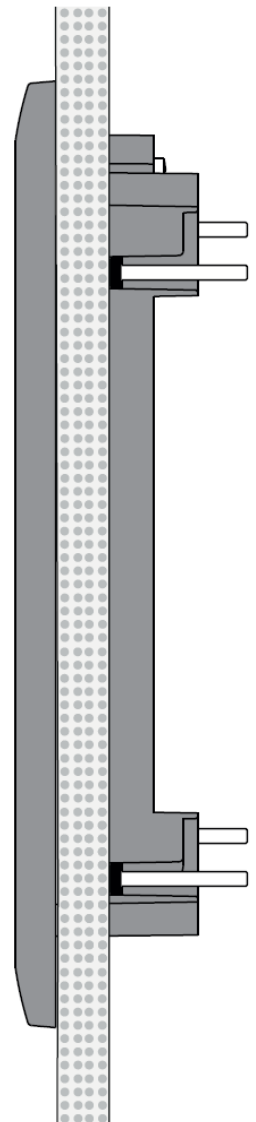

## Wall Mounting

Use the wall (surface) mounting box, part No. **9153003**, and follow the instructions enclosed.

## 2.3 Electric Installation

This subsection describes how to connect 2N® Helios Uni into your Local Area Network (LAN) and how to connect supply voltage and the electric lock.

### PCB Connectors

#### Description of Connectors

<b>LINE</b>	An analogue telephone line with any polarity, or an RJ connector or terminals
<b>12V AC, DC</b>	AC/DC backlight or additional amplifier supply (DC must be used for the amplifier)
<b>tamper N.C.</b>	Open cover signalling contact (N/C)
<b>GND</b>	ground (mandatory) 
<b>door N.O.</b>	Electric lock switch (N/O)

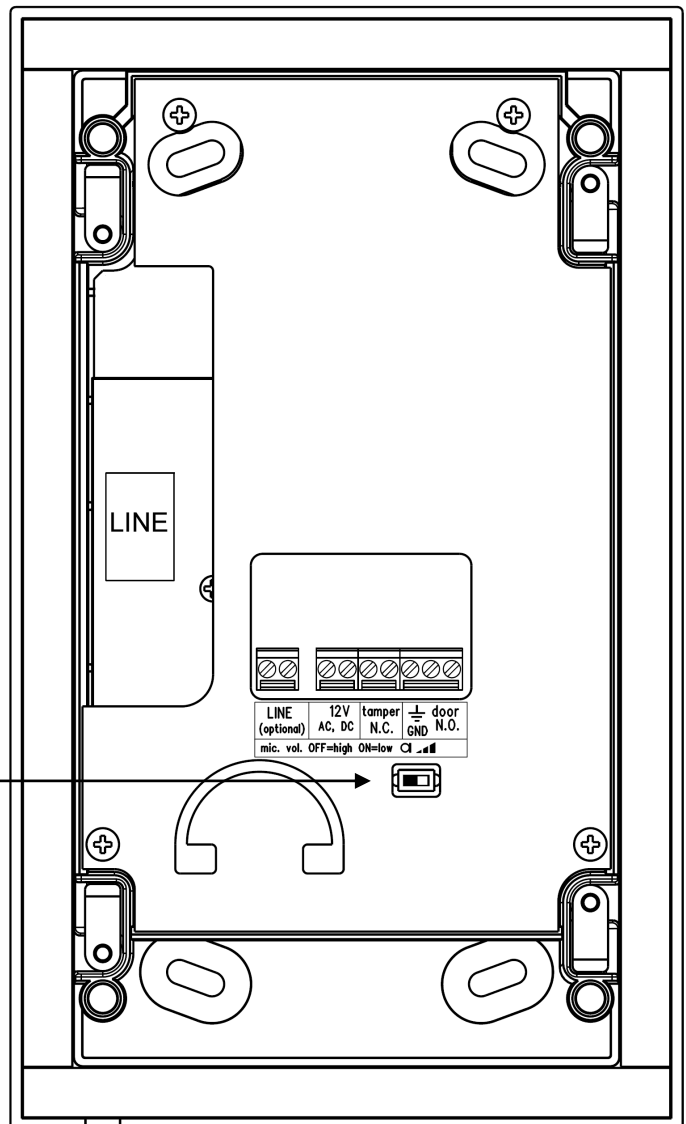

Microphone level low switch

## Compatibility

**2N® Helios Uni** is designed for conventional, analogue telephone lines and works regardless of polarity and line parameters. (Refer to the Technical Parameters) and uses tone (DTMF) or pulse dialling to be programmed. Normally, it is connected to a PBX line however it can also be connected to an analogue line or the GSM interface providing a wireless installation.

## Connection to Telephone Line

Connect **2N® Helios Uni** simply using LINE terminals. The advantage is that **2N® Helios Uni** requires no power supply because all power is fed from the telephone line – except for the button backlight and electric lock, if connected. Nevertheless, **2N® Helios Uni** can work without these circuits too and sends an acoustic signal on having been connected to a line (or after having been disconnected from the line for a defined period of time).

## External power Supply and Electric Lock Connection

**2N® Helios Uni** requires 12V supply for:

1. Name tag backlight – current draw of up to 5 mA, AC or DC
2. Electric lock – current draw according to the lock type\*)
3. Additional amplifier if available – current draw of up to 100 mA, DC only!

\*) The electric lock can be fed from the same source as the intercom or another supply.

**2N® Helios Uni** contains a solid-state switch equipped with V-MOS transistors, which is able to switch both AC and DC regardless of polarity. Make sure that the current and voltage values do not exceed limits (refer to the Technical Data) and that the technical parameters of the lock and power supply are compatible.



### Danger!

- Never switch 230 or 120 V mains voltage directly!!!



### Caution

- If the lock power supply fails and the telephone system carries on working, the intercom is unaware of the failure the switch will be password-activated and the activation is acoustically signalled, but the electric lock will not work because of the lack of power.
- Ground connection is mandatory. If used power supply output is grounded, you can connect GND terminal to it.

Make sure that the power supply is able to supply the required current. Connect the supply and lock as shown in the figure below:

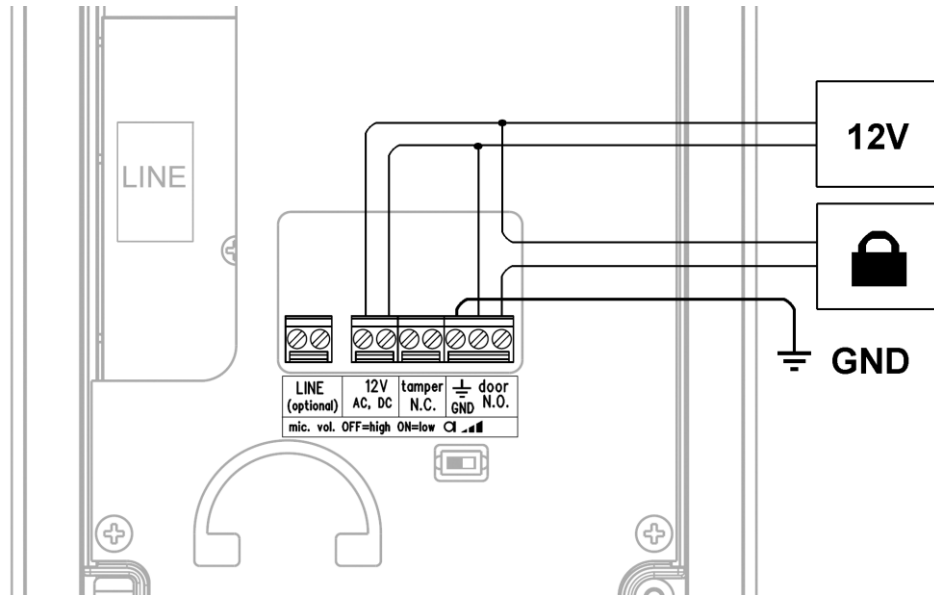

### Separate Backlight and Electric Lock Supply

Separate power supplies are necessary e.g. where the lock requires voltage higher than 12 V. In this case, an additional power supply (12V) must be used to illuminate the button backlight - see the figure below:

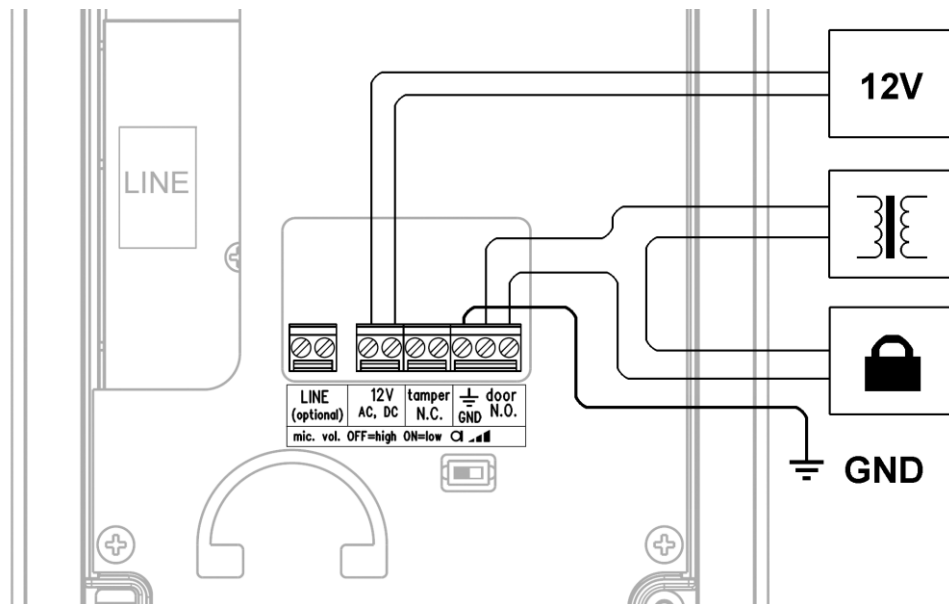

## 2.4 Button Tags – Insertion, Replacement

### Tag Printing

1. Every name plate includes a piece of foil, which can be written over manually, using a waterproof permanent marker.



#### Note

- Always use waterproof foil (enclosed or other) for the tags. Never use paper or ink jet printing to avoid damage due to water leakage!

### Tag Inserting / Replacing

**2N® Helios Uni** provides an intuitive, easy access to the name plates. The tags are easy to insert and replace even without a manual. You need not remove the front panel and thus are not exposed to the risk of loss of components while replacing the tags.

1. Loosen the name plate screw using the wrench enclosed, for example. You can open the name plate window like a door without losing the tightened screw.
2. Remove the used or blank name tag and insert a new tag.
3. Close the name plate window and tighten the screw appropriately.
4. Check the click effect of the buttons: if the button fails to click properly when pressed (when moved by approx. 0.5 mm), the tag is too thick or thin. Make sure that the button clicks when you press it on either end.

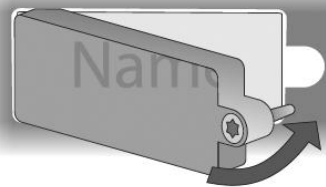
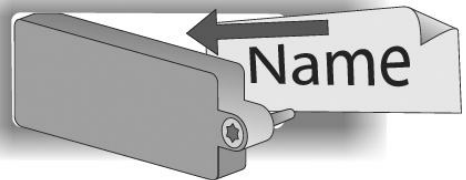
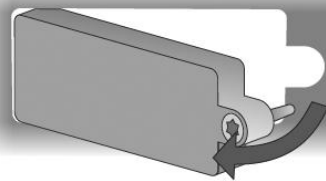
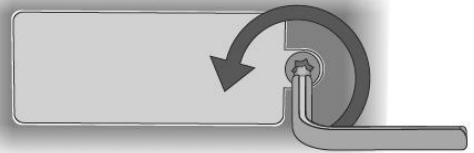

# 3

## Function and Use

In this section we describe the basic and extending functions of the **2N<sup>®</sup> Helios Uni** product.

Here is what you can find in this section:

- Programming
- Full parameter chart
- Function description
- Section for advanced users
- Maintenance

## 3.1 Programming

All the intercom parameters, including the keypad ones, are set remotely using any tone-dialling telephone set (or a mobile phone). First call the intercom and enter the programming mode. The access to this mode is service password protected.

A voice menu is available in the programming mode and so you need not use this manual to program standard parameters. The menu is stored in the intercom memory in the default language. Having entered the full parameter or memory number, you can hear how the parameter has been programmed, thus checking the programmed numbers for correctness.

All parameters are stored safely in the non-volatile EEPROM memory.



### Tip – Before You Start Programming

- Write or print the values to be programmed to minimise the risk of error. Moreover, this gives you an idea of what you have programmed. Make sure that programming is not barred (JP1 jumper) – refer to the PCB Description subsection.

## Entering Programming Mode

You can enter the programming mode only during an incoming call (telephone – intercom call). The programming barring jumper must not be mounted. To get into the programming mode, enter the service password in the format  **password**  (do not forget to enter the asterisks before and behind the password!). The service password is 12345 by default and can be changed. If you enter the password correctly, the voice menu is launched. Now you can start programming.

## Programming Procedure

You can set parameters in any order and as many times as you wish. To change a parameter use the following command:

**Parameter number**  **parameter value**

A three-digit **parameter number** is assigned to every parameter to be programmed and to every memory (refer to the Programming Chart). This number indicates to the intercom which parameter to change, and  is used as "Enter". When it is entered, the intercom repeats the parameter (or memory) number and reads the current contents (excluding passwords). Now you can enter new data – of variable meaning and length depending on the parameter selected (refer to the Full Parameter Chart). Finally, press  again for confirmation. The intercom confirms the data saving. Repeat this procedure for each parameter.

## Switch Password Programming

Each switch can be controlled with up to 10 different passwords that are listed in the intercom memory. Passwords can be added to the list using function 811 and deleted with function 812 individually. The default status is a single password in the list,



namely **00** for switch 1. This special password cannot be entered from the intercom keypad. To cancel them, you have to remove them from the list:

8) 1) 2) \* 0) 0) \*

Function 997 deletes the entire password list including the password 00. Function 999 deletes the entire password list too but recovers the password 00 and the service password 12345.

## Password Selection Restrictions

Controlling the switch by phone, you can enter the password without any starting and terminating characters and the password length is not limited. The intercom has to verify after every character received whether the password is complete or not.

Therefore: **make sure that no password is identical with the beginning of another password.**

- Should you use such confusing passwords for switch control, you have to enter the longer password (by phone) with asterisks at the beginning and end.
- If the intercom refuses to store a password, it means that the switch password list is full, or the password has already been entered.
- The switch password may not be identical with any Arrival/Departure, Day/Night, or service password.
- For password selection tips see the Instructions for Keypad Use.

## Programming Error

- Any wrong value can be re-programmed by another command (immediately or any time later).
- If you make a typing error, cancel the entered value with [#]. Then you can re-enter the whole number.
- If you enter an incorrect parameter number or parameter value, the intercom sends a refusal signal and you have to start with the parameter number again.
- If you do not press any button within a predefined timeout, the intercom sends a hang-up signal and hangs up. The timeout is 5 seconds; every \* character is followed by 30 seconds for you to think over your setting. The 5-second limit starts when the intercom has read all that relates to the current user position in the programming menu. The timeout can be prolonged – see the chart.



### Tip

- **To check programmed values:** enter parameter number and \*, listen the parameter value and press # for return to the main menu.

## Deleting All Passwords, All Memories, Complete Initialisation

---

The following three functions facilitate your programming by clearing all previous settings:

- **997**  
deletes the entire password list for switch including password 00.
- **998**  
deletes memories of all buttons (01 - 02) plus Arrival/Departure and Day/Night passwords.
- **999**  
clears the whole memory and resets the default values (see the chart).

### Protection against Unintentional Deletion

The above functions need no special "value" but must be protected against unintentional initiation. Therefore, enter the service password as the value. Warning: Full initialisation takes a few seconds, the intercom sends a continuous tone while memory clearing. Functions 997 and 998 take a little less time and are signalled by a continuous tone too.

The button memories can be deleted individually too – just enter a "blank" while programming. For example:      clears memory 1 of button 01.

## If You Forget the Service Password

---

If you forget the service password, contact the manufacturer. The manufacturer can change your service password to 12345 remotely without altering any other parameter.





### Password Selection Tip

- Keyboard letters facilitate password remembering. For example, it is easier to remember a 9-letter word (e.g. crocodile) than a 9-digit number (276263453).

## 3.2 Full Parameter Chart

Parameter (function)	Parameter Name	Range	Default	Note
<b>011 to 016</b>	Button 01 memories	Up to 16 digits	blank	
<b>011 to 026</b>	Button 02 memories	Up to 16 digits	blank	
Digits 0-9 can only be entered directly into the memories. Special characters are entered additionally using function XX7 :				
<b>017 or 027</b>	Enter special chars  ,  and pause	<b>Entering format:</b> Button number, 01 - 02 ———— 1 =  2 =  3 = space ———— Button memory number, 1 - 6 ———— Character position, 01 - 16 ————		
<b>018 or 028</b>	Button 01 or 02 count of automatic dialling cycles	0-9	0 = off	
<b>019 or 029</b>	Button 01 or 02 Arrival/Departure password	up to 16 digits	blank	
<b>559</b>	Day/Night password	up to 16 digits	blank	The same as for Arrival/ Departure, identical for all buttons
<b>811</b>	Enter up to 10 switch passwords	up to 16 digits	00	Password 00 cannot be entered from the keypad! Up to 10 switch passwords Delete passwords using function 812
<b>812</b>	Delete valid switch passwords	Valid password		Deletes individual valid switch passwords.
<b>813</b>	Switch closing time	0-9 s	5s	0 = switch disabled
<b>901</b>	Dialling type	0-1	0 = tone	1=pulse 40/60
<b>902</b>	Dialling timeout after pick-up	5-99	8 = 0.8s	Range of 0.5 - 9.9s
<b>903</b>	DTMF transmitting level	0-12	6	1 step = 1 dB

Parameter (function)	Parameter Name	Range	Default	Note
<b>904</b>	Automatic Multiple Number Dialling type	0-3	0 = disabled for all buttons	1 = loud with confirmation 2 = silent with confirmation 3 = SP without confirmation <sup>1)</sup> 4 = SP without confirmation <sup>1)</sup>
<b>906</b>	Ticking into call	0-12	0 = off	The called party recognises better that the incoming call is from the intercom.
<b>911</b>	Count of rings before incoming call answering	1-99	2 	Warning!!! No connection is established if a higher value is entered than as allowed in the PBX ringing timeout!!!
<b>912</b>	Max. call duration	1-99	12 = 120s	Range of 10s-990s
<b>913</b>	Log-in timeout	1-99	3	3 = 30 seconds
<b>915</b>	Hang-up time between calls	5-99	15 = 1.5 s	
<b>931</b>	Microphone power-up level	0-3	2	0 = Maximum microphone sensitivity
<b>932</b>	Automatic response speed	0-3	2	3 = Maximum response speed
<b>933</b>	Reception volume	0-15	7	15 = Maximum reception volume
<b>934</b>	Transmission volume	0-15	7	15 = Maximum transmission volume
<b>935</b>	Message volume	0-15	7	15 = Maximum message volume
<b>936</b>	Beeping volume	0-12	12	12 = Maximum tone volume
<b>937</b>	DTMF hearing (side tone) volume	0-3	3	3 = Maximum DTMF volume
<b>938</b>	Loudspeaker volume	0-15	7	15 = Maximum loudspeaker volume
<b>941</b>	Minimum continuous tone time	10 - 99	20 = 2s	If the tone is longer, the intercom hangs up.
<b>942</b>	Minimum busy tone or pause duration	0-255	8 = 0.08s	These parameters control the busy tone detection. They are used for call termination and automatic dialling.
<b>943</b>	Maximum busy tone or pause duration	0-255	70 = 0.7s	
<b>944</b>	Maximum tone-pause difference	0-255	10 = 0.1s	
<b>945</b>	Minimum count of busy tone periods	2-9	4	

Parameter (function)	Parameter Name	Range	Default	Note
<b>946</b>	Dual tone detection setting	0 - 10	4 = 440 Hz	All continuous, busy and ringing tones are detected. Dual tones are detected if one of their components is between 400 and 500 Hz. If both components are in this range, set a lower detection value. Set 0 for 400 Hz and 10 for 500 Hz. <i>This setting does not affect the single tone detection, which always works between 300 and 550 Hz.</i>
<b>951</b>	Minimum ringing tone time	1 - 200	50 = 0,5 s <sup>2</sup> )	 Warning! As these parameters also detect incoming calls, an incorrect setting may result in the intercom not answering the call!
<b>952</b>	Minimum long pause time	5 - 100	10 = 1 s	
<b>953</b>	Maximum long pause time	10 - 100	60 = 6 s	
<b>954</b>	Count of ringing periods	1 - 99	10	If the preset count of periods is exceeded, the call is terminated.
	If the preset count of periods is exceeded and automatic dialling is enabled, another attempt follows. In the event of Automatic Dialling <u>without Confirmation</u> , the ringing tone is recognised and ends before the preset count of periods is exhausted; the call is regarded as successful.			
<b>961</b>	Maximum timeout for pressing the next digit	1-9	5 s	During password entering, etc.
<b>963</b>	Possibility to hang up by pressing the same button	0 = no 1 = yes	1	
<b>964</b>	Possibility to dial the next number by pressing 2nd button	0 = no 1 = yes	1	
<b>971</b>	Count of message repetitions	0 - 9	3	There is a 3-second pause between every two messages.
<b>974</b>	Intercom identification number	16 digits	-	The number enables intercom identification.
<b>975</b>	Message options for automatic multiple number dialling	2 digits	55	<b>1<sup>st</sup> digit</b> = type of message repeated after dialling. <b>2<sup>nd</sup> digit</b> = type of message after confirmation. The following digits are used: 2 = identification (974) - loud speaking 4 = identification (974) - DTMF 5 = message as defined in par. 977 (after confirmation by par. 976) 7 = confirming tone (after

Parameter (function)	Parameter Name	Range	Default	Note
				confirmation only)
<b>976</b>	language selection for a message	0 - 8	1	0 = 🎵 1 = English 2 - 3 = 🎵 4 = German 5 - 7 = 🎵 8 = Portuguese 9 = Dutch 10 ... 99 = silence
<b>977</b>	language selection for "wait, please" message	0 - 8	1	Note: See <b>Survey of messages</b> in Subs. 4.2 <b>Caution!</b> Czech version has language order: 1 = Czech, 2 = English
<b>991</b>	Service password		12345	12345 by default
<b>995</b>	Software version identification	-		This function reads out the current software version. Format: year-month-day. Writing disable.
<b>997</b>	Deletion of all switch passwords		12345	Deletes password 00 too.
<b>998</b>	Clearing of all memories	Service password	12345	Clears memories 01 to 55.
<b>999</b>	Full initialisation		12345	Warning! Changes the service password too (setting the default value of 12345).



### Notes

- Terminology: For the purpose hereof, **parameter** means a **value** that is stored in the intercom memory and can be re-programmed. **Function** is a means of execution of another service such as initialisation, software version identification and so on.
- <sup>1)</sup> Types 3 and 4 of Automatic Dialling without Confirmation differ from each other in how they process very short calls (a few seconds). Dialling type 4 regards a call as successful in all cases, type 3 only if the door was opened.

## Explanation of Some Parameters

### Explanation of Parameters 951, 952, 953

#### Ringing tone (example)

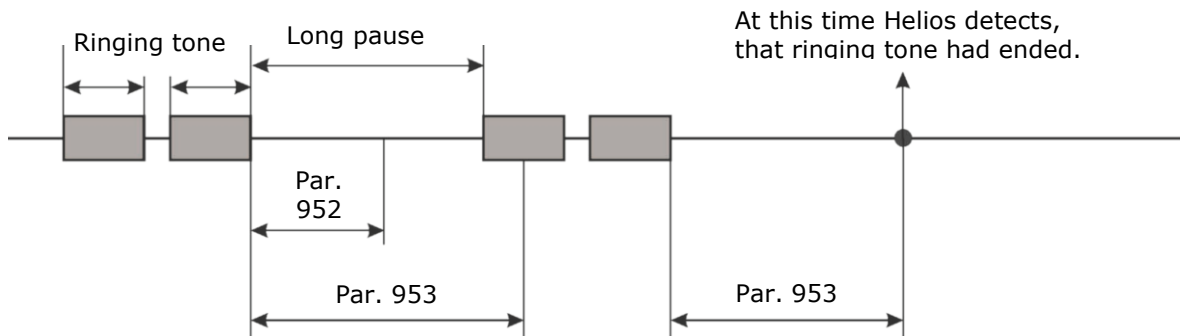

### Explanation of Parameters 942, 943, 944

#### Busy tone

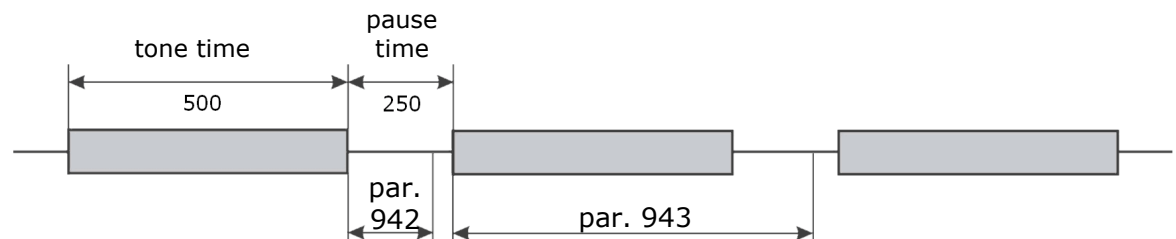

#### Example:

The busy tone in the figure above is considerably longer than the pause time. Therefore, set parameter **942** according to the pause, to 200 ms, e.g., and parameter **943** according to the tone, to 600 ms, for example. In this case, however, the default values can be maintained for both the parameters. Since the tone – pause difference is  $500 - 250 = 250$  ms, **set parameter 944** to 300 ms, for example.



#### Note

- Increase parameter 944 also when the intercom is placed in a hall or corridor with a large decay time.

## 3.3 Function Description

### From External User's View (Visitor)

Like normal doorbells, intercom buttons are provided with labels. The visitor finds the appropriate button (e.g. Mr. Smith) and presses it. This activates the intercom, which then dials the number pre-programmed for that button. The visitor can then hear the ringing tone from the loudspeaker and the required (Mr. Smith's in this case) telephone is ringing. If the intercom is connected to a telephone system, you can tag the port the intercom is connected to in order to see on the ringing phone that it is the intercom that is calling. When the called party answers the call, the visitor and the called person can speak to each other and, if an electric lock is connected to the intercom, the called person can open the door by entering the correct password on the telephone keypad to activate the door or barrier. When the caller hangs up, the intercom detects the PBX or analogue line tone and hangs up too. The intercom also hangs up when it "hears" the busy tone or if the call takes more time than as pre-programmed to connect. You can pre-program the amount of time that you have to speak into the microphone, but when you reach the programmed time, the unit will send a warning tone 10 seconds before hanging up so that the called party can extend the call if required.



#### Note

- If the visitor presses another button during the call, the intercom hangs up for a few seconds before dialling the new number.
- If a button is pressed that has no number stored within it, the intercom picks up the line, sends a refusal tone (refer to the Signals Overview) and hangs up.
- If the visitor presses the same button during the call, the intercom may hang up (can be programmed to stop this feature if required).
- The above mentioned rules are only applied if the Automatic Multiple Number Dialling mode is OFF. For this special mode refer to the Automatic Multiple Number Dialling section.



## From Internal User's View (Survey of Functions)

### Calling to 2N® Helios Uni

You call the appropriate extension and the intercom makes the call and gives a confirmation tone after two rings (or as pre-programmed). Now you can speak and control the switch, program the intercom (see later), and listen to what is going on outside and speak to the calling party if desired.

### Door opening

The intercom contains a switch to which an electric lock can be connected (not included in this pack). This switch can be telephone keypad controlled using a (digital) password in two ways as shown in the default password 00 example below:

0 0

or

\* 0 0 \*

The switch activation time can be programmed once the switch is enabled this will also automatically terminate the call in the next 30 seconds.



#### Note

- If the Automatic Multiple Number Dialling with Confirmation or the Silent Automatic Multiple Number Dialling with Confirmation mode is selected and the password starts with digits 1 to 5, an asterisk must always be used.
- **You Must** enter every digit in the password within five seconds (or as pre-programmed) to avoid the intercom hanging up.

### Switch activation signalling

After the correct password is entered, the switch is activated and you can hear the confirmation signal on your telephone. You can now speak (e.g. say: "The door is open") or listen (to the door-opening sound, etc.) until the switch is deactivated. Upon deactivation, you can hear the storing signal (see the Signals Overview).

### Call extension

The intercom beeps 10 seconds before the call end. To extend the call by 30 seconds press \* on your telephone (DTMF). You can use this function repeatedly. The visitor, however, cannot use this function!

### Programming





The access to this mode is password-protected. For details refer to the Programming section. The voice menu helps you considerably with programming the intercom. Having entered the programming mode, you can also alter any parameter and memory settings.



#### Caution

- The above mentioned functions (except for calls to the intercom) require a **tone-dialling** telephone set.

## Signals Overview

Signal	Name	Meaning
	Confirmation	<ul style="list-style-type: none"> <li>Sent immediately after line seizure for incoming calls (can be heard by the calling party).</li> <li>Signals switch activation (by DTMF) - can be heard by the person "at the other end" who activated the switch.</li> </ul>
	Refusal	<ul style="list-style-type: none"> <li>Signals that a non-programmed button has been pressed.</li> <li>Can be heard from the loudspeaker after line connection (first connection signalling).</li> <li>Signals an incoming call if intercom has not been programmed</li> </ul>
	Storing	<ul style="list-style-type: none"> <li>Signals switch deactivation (if activated by DTMF).</li> </ul>
	Hang-up	<ul style="list-style-type: none"> <li>Sent to notify that the call is terminated (in all cases).</li> </ul>
Long continuous tone		<ul style="list-style-type: none"> <li>Signals that the unit is going through full initialisation or dialling memory or password clearing.</li> </ul>
"Attention, your call is being terminated"		<ul style="list-style-type: none"> <li>Signals that the preset maximum call time will elapse within 10 seconds.</li> </ul>
"Wait, please"		<ul style="list-style-type: none"> <li>Optional message during call establishing.</li> </ul>
"Communicator number ..... is calling"		<ul style="list-style-type: none"> <li>Optional message for intercom identification</li> </ul>
Voice menu		<ul style="list-style-type: none"> <li>In the programming mode</li> </ul>

## Call Termination Options - Summary

1. The busy or continuous tone \*) after the call end.
2. The ringing tone \*) after a predefined count of rings.
3. The subscriber 'at the other end' pressed [#].
4. The preset maximum call duration has elapsed.
5. 30 seconds after the switch use has elapsed.
6. An intercom button was pressed during the call.

\*) *The intercom is able to detect a permanent tone, busy tone and ringing tone even if the tone has two frequency components as in the UK, the U.S.A. (the so-called BTT tone) and in Canada. This new function does not require setting of any parameter. One of the tone components must be of 440 Hz.*

## 2N® Helios Uni Statuses and Available Operations

Operation	Hang-up	Outgoing call	Incoming call	Programming
Button pressing – new call	✓	x	---	---
Call extension - DTMF <input type="checkbox"/>	---	✓	✓	---
Call termination - DTMF <input type="checkbox"/>	---	✓	✓	✓
Hang-up upon continuous, busy or ringing tone	---	✓	✓	✓
Switch activation – DTMF password	---	x	x	---
Programming start	---	---	✓	---

### Explanatory notes:

✓... Yes, always

x ... Yes if this function is programmed

## 3.4 Section for Advanced Users

### Automatic Multiple Number Dialling

When you press an intercom button, you may find out that the called line is busy or the called party is absent. The intercom is able to identify these situations and solve them by Automatic Multiple Number Dialling if one of three automatic dialling modes is enabled. Up to 6 numbers can be stored for each button.

The three automatic modes (see below) recognise the continuous, busy and ringing tones. In all of these modes, automatic dialling can be disabled or the required count of cycles can be preset (1 to 9; if none of the stored numbers is answered, the whole cycle is repeated starting with the first number again) for each button separately.

You can program Automatic Multiple Number Dialling for selected buttons only, retaining the others in the default mode, the selection of one of three automatic dialling modes is common.

### Automatic Multiple Number Dialling without Confirmation

This mode can be used in common cases to enable the visitor to get through even if the called line is busy or the called subscriber is absent. Hence, the second memory of the button may include the secretary's number, the third memory the porter's lodge number, etc.

This mode recognises the ringing tone and if the tone ends before the predefined count of rings, the intercom regards this as a successful connection, this solution is not fully reliable because detection may be hindered by noise, etc. No message is played back in this mode.

#### Evaluation of Situations in Audible Automatic Dialling without Confirmation

Situation	Intercom Action
Busy tone	Hangs up in approximately 2 seconds and dials the next number.
Call or silence without previous ringing tone	Waits for the preset timeout (log-in time), then hangs up and dials the next number.
Continuous tone (at the PBX, e.g.)	Hangs up in approximately 2 seconds and dials the next number.
Ringing tone, which is terminated before 10 rings are made (the count of rings is variable)	Regarded as a successful call, continues for the maximum timeout (maximum call duration). For details refer to the text under the table.
Ringing tone, 10 rings are made (the count of rings is variable)	Hangs up and dials the next number.
1 to 9, 0	These digits are interpreted as password beginning.
*	Call extension or password beginning.
#	Hang-up command.

If the ringing tone stops before the predefined count of rings is achieved and the call is thus very short (e.g. 2 seconds), it is not clear whether the call should be regarded as successful. Therefore, a new type of automatic dialling has been added - type 4.

**The difference is as follows:**

- Type 3 regards such a call as successful only if the door is opened.
- Type 4 regards all such calls as successful.

## Automatic Multiple Number Dialling with Confirmation

This mode is used where maximum connection reliability is required – for emergency calls. The called line (the supervisory control centre, e.g.) must be operated by a well-trained person to confirm connection. The DTMF is used as the most reliable criteria for successful connection. The called line must press **1** on its telephone. If the called number is busy or remains unanswered until the preset timeout or in other cases (see the table), the intercom dials the next number in the sequence.

### Evaluation of Situations in Audible Automatic Dialling with Confirmation

Situation	Intercom Action
Busy tone	Hangs up in approximately 2 seconds and dials the next number.
Call or silence	Waits for the preset timeout (log-in time), then hangs up and dials the next number.
Ringing tone	Waits for the preset count of rings, then hangs up and dials the next number.
Continuous tone (at the PBX, e.g.)	Hangs up in approximately 2 seconds and dials the next number.
DTMF char <b>5</b> or <b>#</b>	Immediately hangs up and dials the next number.
DTMF char <b>1</b>	Confirms reception (2 beeps) and the call continue for the preset time at most (maximum call duration).
<b>1</b> <b>2</b> <b>3</b> <b>4</b> <b>5</b>	These digits are interpreted as control characters - refer to the DTMF Control subsection.



#### Note

- It is sometimes difficult to recognise the above-described situations reliably due to a poor quality of the PSTN connection. Excessive noise in the surroundings may also have a negative impact. However, this may only decelerate automatic dialling (the busy tone may not be recognised, e.g.). Even if the intercom cannot identify the DTMF, the connection is established (yet for a shorter time).

## Silent Automatic Multiple Number Dialling

This mode fully conceals the fact that a telephone call is made. When a button is pressed, the loudspeaker is off and no PBX or dialling tone can be heard. The loudspeaker is switched on when the called subscriber confirms connection (by pressing  on its telephone). Thus, a potential thief cannot establish whether the called person is in the building or not.











Otherwise, the function is the same as with Automatic Multiple Number Dialling with Confirmation.

## 2N® Helios Uni Identification

There are situations in which the calling person does not want to or cannot speak for security reasons in the automatic dialling mode. In these cases, the intercom can play back a message stored in its memory. The test series includes the "Wait please, connection is being established" message. Later, more messages will be available to the user.

## DTMF Control

If Automatic Multiple Number Dialling with Confirmation or Silent Automatic Multiple Number Dialling is enabled, the intercom can be controlled as shown in the table below. For convenience, commands 1 to 5 are arranged as they are usually used.

DTMF Character	FUNCTION
	<b>Confirmation</b> indicating to the intercom that the call was successful. The intercom sends its confirmation signal, the call goes on until the end of timeout and any of the following commands can be used.
	Message <b>muting</b> (during playback). <b>WARNING!</b> You may not speak while the intercom is playing back the message!!!
	Message <b>re-plays</b> (once).
 or 	<b>Call extension:</b> a call is extended by 30 seconds by this command. Can be used repeatedly.
 or 	Call <b>termination</b> .
 to  , 	These digits are interpreted as a password beginning - for switch control.



### Notes

- These commands do not work in the Automatic Multiple Number Dialling mode without Confirmation!
- The above-mentioned commands **may not be accepted** due to poor connection if sent during a message. To avoid this, press the button during the time of silence (between messages).

## Survey of Messages

The table below includes a survey of language versions for standard announcements. English is selected by default. To select another language, use parameters 976 and 977.

Value of parameter <b>976</b>	Language selection – English version	End of call message	Outgoing call message	
			ID message. Parameter 975 must contain digit 2, 3 or 5	Confirmation message. Parameter 975 last digit = 5
0	Tone signal	♪♪	off	off
<b>1</b> (default value)	<b>English</b>	<b>Attention, your call is being terminated.</b>	<b>Communicator number..... is calling .</b>	<b>Connection confirmed.</b>
2	German	Achtung, das Gespräch wird beendet.	Es ruft das Notruftelefon Nummer.....an.	♪♪
3	Portuguese	.....	.....	♪♪
4	Dutch	.....	.....	♪♪

Value of parameter <b>977</b>	Language selection – English version	Outgoing call message	Note
0	Tone signal	off	<ul style="list-style-type: none"> <li>• To play this message, parameter 975 must start with digit 5.</li> <li>• Parameter 977 has a range 0 – 99. On customer's request, additional messages can be added; e.g. other languages or more alternative messages in one and the same language.</li> </ul>
<b>1 *</b>	<b>English</b>	<b>Wait please.</b>	
2	German	Warten Sie bitte.	
3	Portuguese	.....	
4	Dutch	.....	

## Arrival/Departure, Day/Night Modes

**2N® Helios Uni** can identify easily where to 'route' (switch) a call after a button is pressed. All you have to do is call the intercom and enter the following:

**I'm leaving:**                    ☒ password ☒ 1 ☒

**I'm back:**                        ☒ password ☒ 0 ☒

All buttons can be switched all at once by a common **Day/Night password** or individually by separate **Departure/Arrival passwords**.

### How does switching work?

- Every button has memories for 6 numbers (intended primarily for Automatic Multiple Number Dialling).
- If the Automatic Multiple Number Dialling mode is **OFF**, memory **1** is used for the Day mode and memory **3** for the Night mode. This is a simple two-number switching.
- If the Automatic Multiple Number Dialling mode is **ON**, memories **1, 2, 3, 4, 5, 6** are used for the Day mode and memories **3, 4, 5, 6** are used for the Night mode in the above-mentioned order. This accelerates the process; numbers that would not be answered are skipped over.
- If the Night mode is on and memories 3 to 6 are empty, memories 1 and 2 are used.
- If the **Night** mode is on, memories 1 and 2 are omitted for **all** buttons and this cannot be disabled individually using the Arrival function.
- In the Day mode, the buttons assigned to persons who used the Departure function (are on a leave) shall remain in the Night mode until the same persons use the Arrival function (after the leave, e.g.).

### Example 1 – administration building, automatic dialling is off:

Button 01: labelled Mr. Smith, memory 1 = Mr. Smith's line, memory 3 – secretary's line, password for button 01 is 777.

7. *Mr. Smith is leaving for holiday. He calls the intercom and enters:*  
☒777☒1☒
8. *A visitor comes, presses Mr. Smith's button – the intercom calls the secretary.*
9. *Mr. Smith comes back. He calls the intercom and enters:* ☒777☒0.

### Example 2 – family house, Silent Automatic Multiple Number Dialling:

Button 01: labelled The Johnsons, memory 1 = living room, 2 = workshop, 3 = Mr. Johnson's mobile telephone, 4 = Mrs. Johnson's mobile telephone. Arrival/Departure password for button 01 is 333.

10. *The family is leaving for holiday. They call the intercom and enter:*  
☒333☒1☒.
11. *A visitor presses the Johnsons' button – the intercom calls Mr. Johnson's mobile phone and, if unsuccessful, Mrs. Johnson's mobile phone.*



## 3.5 Maintenance

### Cleaning

---

If used frequently, the intercom gets dirty. To clean it, use a piece of soft cloth moistened with clean water. We recommend you to obey the following principles while cleaning:

- Never use aggressive detergents (such as abrasives or strong disinfectants).
- Alcohol-based cleaners may be applied.
- Clean the device in dry weather in order to make waste water evaporate quickly.

### Future Tag Replacement, Programming Changes

---

For necessary steps refer to the preceding subsections. Keep the following for future changes:

- This manual
- Unused transparent foil strips for button tags

Always use the product for the purpose it was designed and manufactured for, in compliance herewith.

The manufacturer reserves the right to modify the product in order to improve its qualities.

2N® Helios Uni contains no environmentally harmful components. When the product's service life is exhausted and you would like to dispose of it please do so in accordance with applicable legal regulations.



# 4

## Technical Parameters

In this section we describe the technical parameters of the **2N® Helios Uni** product.

# 4.1 Technical Parameters

<b>Telephone Parameters</b>	Value	Conditions
Minimum required off-hook line current	15 mA	Off-hook
Minimum required on-hook line voltage	20 V	Hang-up
DC voltage drop (off-hook)	< 8 V < 16 V	I = 25 mA I = 50 mA
Lead current while hang-up	< 25 $\mu$ A	U = 60 V
Off-hook AC impedance	220 $\Omega$ + 820 $\Omega$ 115 nF parallel	20 to 60 mA
Return loss	> 10 dB	20 to 60 mA
Bandwidth	300 to 3500 Hz	20 to 60 mA
Ringing impedance	> 2 k $\Omega$ C = 1 $\mu$ F	25 to 50 Hz
Ringing detector sensitivity	10 to 20 V	25 to 50 Hz
Time of response to ringing	Variable	
Pulse dialling	40 / 60 ms	20 to 60 mA
DTMF level	-6 and -8 dB $\pm$ 2 dB	20 to 60 mA
DTMF detector sensitivity	Min. -40 dB	20 to 60 mA
Dial tone detector sensitivity	Min. -40 dB	350 - 500 Hz
Busy tone detection speed	Variable	350 - 500 Hz
Continuous tone detection speed	Variable	350 - 500 Hz
Ringing tone detection speed	Variable	350 - 500 Hz
Overvoltage protection – common mode	1000 V	8 / 20 $\mu$ s
Overvoltage protection – between A, B conductors	1000 V	8 / 20 $\mu$ s

<b>Other Electric Parameters</b>		
	Switch – max. voltage	48 V AC, DC
	Switch – min. voltage	9 V AC, DC
	Switch – max. current	2 A AC, DC
	Backlight – rated voltage	12 V
	Backlight – max. voltage	14 V
	Backlight – current consumption	Up to 5 mA

<b>Buttons</b>		
	Button design	Transparent, white backlit buttons with easily replaceable name tags
	Button count	1 or 2

<b>Audio</b>		
	Microphone	1 integrated microphone
	Amplifier	Optional – additional 0.5 W amplifier

<b>Physical Properties</b>		
	Cover	ABS plastic, high-quality stainless steel
	Working temperature	-25°C to +55°C
	Working relative humidity	10% - 95% (non-condensing)
	Storing temperature	-40°C - 70°C
	Dimensions	193 x 115 x 39 mm 197 x 119 x 47 mm flush box 193 x 115 x 57 mm for wall mounting
	Weight	Net product weight ..... 500 g Flush box ..... 135 g Total weight incl. package ... 800 g
	Protection level	IP54

# 5

## Supplementary Information

This section provides supplementary information on the **2N<sup>®</sup> Helios Uni** product.

Here is what you can find in this section:

- Applicable Directives, Laws and Regulations

## 5.1 Directives, Laws and Regulations

2N<sup>®</sup> Helios Uni conforms to the following directives and regulations:

- Directive 1999/5/EC of the European Parliament and of the Council, of 9 March 1999 – on radio equipment and telecommunications terminal equipment and the mutual recognition of their conformity
- Directive 2006/95/EC of the European Parliament and of the Council of 12 December 2006 on the harmonisation of the laws of Member States relating to electrical equipment designed for use within certain voltage limits
- Directive 2004/108/EC of the Council of 15 December 2004 on the harmonisation of the laws of Member States relating to electromagnetic compatibility
- Directive 2002/95/EC of the European Parliament and of the Council of 27 January 2003 on the restriction of the use of certain hazardous substances in electrical and electronic equipment
- Regulation (EC) No. 1907/2006 of the European Parliament and of the Council of 18 December 2006 concerning the Registration, Evaluation, Authorisation and Restriction of Chemicals (REACH), establishing a European Chemicals Agency, amending Directive 1999/45/EC and repealing Council Regulation (EEC) No. 793/93 and Commission Regulation (EC) No. 1488/94 as well as Council Directive 76/769/EEC and Commission Directives 91/155/EEC, 93/67/EEC, 93/105/EC and 2000/21/EC
- Directive 2002/96/EC of the European Parliament and of the Council of 27 January 2003 on waste electrical and electronic equipment.
- Commission Regulation (EC) No. 1275/2008, of 17 December 2008, implementing Directive 2005/32/EC of the European Parliament and of the Council with regard to ecodesign requirements for standby and off mode electric power consumption of electrical and electronic household and office equipment

## 5.2 Troubleshooting



For tips concerning solutions of other potential problems see [faq.2n.cz](http://faq.2n.cz).



## 5.3 General Instructions and Cautions

Please read this Installation Manual carefully before using the product. Follow all instructions and recommendations included herein.

Any use of the product that is in contradiction with the instructions provided herein may result in malfunction, damage or destruction of the product.

The manufacturer shall not be liable and responsible for any damage incurred as a result of a use of the product other than that included herein, namely undue application and disobedience of the recommendations and warnings in contradiction herewith.

Any use or connection of the product other than those included herein shall be considered undue and the manufacturer shall not be liable for any consequences arisen as a result of such misconduct.

Moreover, the manufacturer shall not be liable for any damage or destruction of the product incurred as a result of misplacement, incompetent installation and/or undue operation and use of the product in contradiction herewith.

The manufacturer assumes no responsibility for any malfunction, damage or destruction of the product caused by incompetent replacement of parts or due to the use of reproduction parts or components.

The manufacturer shall not be liable and responsible for any loss or damage incurred as a result of a natural disaster or any other unfavourable natural condition.

The manufacturer shall not be held liable for any damage of the product arising during the shipping thereof.

The manufacturer shall not make any warrant with regard to data loss or damage.

The manufacturer shall not be liable and responsible for any direct or indirect damage incurred as a result of a use of the product in contradiction herewith or a failure of the product due to a use in contradiction herewith.

All applicable legal regulations concerning the product's installation and use as well as provisions of technical standards on electric installations have to be obeyed. The manufacturer shall not be liable and responsible for damage or destruction of the product or damage incurred by the consumer in case the product is used and handled contrary to the said regulations and provisions.

The consumer shall, at its own expense, obtain software protection of the product. The manufacturer shall not be held liable and responsible for any damage incurred as a result of the use of deficient or substandard security software.

The consumer shall, without delay, change the access password for the product after installation. The manufacturer shall not be held liable or responsible for any damage incurred by the consumer in connection with the use of the original password.

The manufacturer also assumes no responsibility for additional costs incurred by the consumer as a result of making calls using a line with an increased tariff.

## Electric Waste and Used Battery Pack Handling

---



Do not place used electric devices and battery packs into municipal waste containers. An undue disposal thereof might impair the environment!

Deliver your expired electric appliances and battery packs removed from them to dedicated dumpsites or containers or give them back to the dealer or manufacturer for environmental-friendly disposal. The dealer or manufacturer shall take the product back free of charge and without requiring another purchase. Make sure that the devices to be disposed of are complete.

Do not throw battery packs into fire. Battery packs may not be taken into parts or short-circuited either.



2N TELEKOMUNIKACE a.s.

Modřanská 621, 143 01 Prague 4, Czech Republic

Tel.: +420 261 301 500, Fax: +420 261 301 599

E-mail: [sales@2n.cz](mailto:sales@2n.cz)

Web: [www.2n.cz](http://www.2n.cz)