



# 2N<sup>®</sup> Helios IP Force

Security IP Intercom



## Installation Manual

Version 2.3

[www.2n.cz](http://www.2n.cz)

The 2N TELEKOMUNIKACE a.s. is a Czech manufacturer and supplier of telecommunications equipment.



The product family developed by 2N TELEKOMUNIKACE a.s. includes GSM gateways, private branch exchanges (PBX), and door and lift communicators. 2N TELEKOMUNIKACE a.s. has been ranked among the Czech top companies for years and represented a symbol of stability and prosperity on the telecommunications market for almost two decades. At present, we export our products into over 120 countries worldwide and have exclusive distributors on all continents.



2N<sup>®</sup> is a registered trademark of 2N TELEKOMUNIKACE a.s. Any product and/or other names mentioned herein are registered trademarks and/or trademarks or brands protected by law.



2N TELEKOMUNIKACE a.s. administers the FAQ database to help you quickly find information and to answer your questions about 2N products and services. On [www.faq.2n.cz](http://www.faq.2n.cz) you can find information regarding products adjustment and instructions for optimum use and procedures „What to do if...“.



2N TELEKOMUNIKACE a.s. hereby declares that the 2N<sup>®</sup> Helios IP Force product complies with all basic requirements and other relevant provisions of the 1999/5/EC directive. For the full wording of the Declaration of Conformity see the CD-ROM (if enclosed) or our website at [www.2n.cz](http://www.2n.cz).



This device complies with part 15 of the FCC Rules. Operation is subject to the following two conditions: (1) This device may not cause harmful interference, and (2) this device must accept any interference received, including interference that may cause undesired operation.



The 2N TELEKOMUNIKACE a.s. is the holder of the ISO 9001:2009 certificate. All development, production and distribution processes of the company are managed by this standard and guarantee a high quality, technical level and professional aspect of all our products.

# Content

<b>1. Product Overview</b>	<b>4</b>
1.1 Components and Associated Products	6
1.2 Terms and Symbols	19
<b>2. Description and Installation</b>	<b>20</b>
2.1 Before You Start	21
2.2 Mechanical Installation	22
2.3 Electric Installation	32
2.4 Extending Module Connection	39
2.5 Button Tags	62
<b>3. Function and Use</b>	<b>63</b>
3.1 Configuration	64
3.2 Control	68
3.3 Maintenance	70
<b>4. Technical Parameters</b>	<b>71</b>
<b>5. Supplementary Information</b>	<b>75</b>
5.1 Troubleshooting	76
5.2 Directives, Laws and Regulations	77
5.3 General Instructions and Cautions	79

# 1. Product Overview

---

Here is what you can find in this section:

- [1.1 Components and Associated Products](#)
- [1.2 Terms and Symbols](#)

## Basic Features

**2N® Helios IP Force** is a highly resistant and reliable IP door access intercom provided with a lot of useful above-standard functions. Supporting the SIP standard and being compatible with the leading IP PBX and telephone suppliers, **2N® Helios IP Force** can make use of all VoIP services. **2N® Helios IP Force** can work as a standard or emergency door access intercom for buildings, entrances to premises or garages, manufacturing halls, highways and so on.

**2N® Helios IP Force** is equipped with two very sensitive microphones and an up to 10W loudspeaker. Thanks to an integrated acoustic echo cancelling (AEC) system, the product provides mutual audibility even of persons talking at the same time under normal conditions.

**2N® Helios IP Force** can be equipped with a colour wide-angle camera, which displays the calling person on the called party's video telephone or PC monitor.

**2N® Helios IP Force** can be provided with 1, 2 or 4 pre-programmed buttons. You can set up to three telephone numbers and time profiles for each of the buttons to increase the accessibility of the called party.

**2N® Helios IP Force** can be equipped with a numerical keypad to be used as a code lock for lock switch activating or telephone/subscriber number dialling.

**2N® Helios IP Force** is equipped with an electric lock switch. You can control the switch using a numerical keypad or, during a call, using any telephone set. An additional switch module can be installed if necessary. A wide range of settings allow for a variety of applications.



**2N® Helios IP Force** can also be provided with RFID card reader modules.

**2N® Helios IP Force** is very easy to install. All you have to do is connect the system into your LAN via a network cable and feed it from a 12 V power supply or your PoE supporting LAN.

Configure **2N® Helios IP Force** using your PC via any web browser. Use the **IP Manager** to manage extensive **2N® Helios IP Force** systems easily and quickly.







## Advantages of Use







- Uncompromising Antivandal design
- High coverage level – up to class IP69K
- Variable mounting options (brick/plasterboard flush mounting, surface mounting)
- Sensitive microphone and powerful loudspeaker
- Bidirectional communication – acoustic echo cancelling
- Integrated colour camera with wide-angle lens
- Optional dial buttons including name tags and backlight
- Optional numerical keypad with backlight
- Integrated electronic lock switches with wide setting options
- Optional integrated RFID card reader module
- LAN (PoE) or external 12 V power supply
- Configuration via web interface or dedicated PC application
- SIP 2.0 support
- Up to 1999 telephone directory positions
- Up to 20 user time profiles
- Video codecs (H.263, H.263+, H.264, MPEG-4, JPEG)
- Audio codecs (G.711, G.729, G.722, L16/16kHz)
- HTTP server for configuration
- SNTP client for time synchronisation with server
- RTSP server for video streaming
- SMTP client for e-mail sending
- TFTP client for automatic configuration and firmware update

# 1.1 Components and Associated Products







**2N<sup>®</sup> Helios IP Force** Components and Associated Products:

## Basic Units

		
<p><b>Part No. 9151101</b></p> <p>1 button</p> <p>control of two electric locks</p> <p>possibility of connecting additional switch</p>	<p><b>Part No. 9151101C</b></p> <p>1 button</p> <p>camera</p> <p>control of two electric locks</p> <p>possibility of connecting additional switch</p>	<p><b>Part No. 9151101W</b> IP69K</p> <p>1 button</p> <p>10 W loudspeaker</p> <p>extra robust version</p> <p>control of two electric locks</p> <p>possibility of connecting additional switch</p>
		

<p><b>Part No. 9151101CW</b> IP69K</p> <p>1 button camera 10 W loudspeaker extra robust version control of two electric locks possibility of connecting additional switch</p>	<p><b>Part No. 9151104</b></p> <p>4 buttons control of two electric locks possibility of connecting additional switch</p>	<p><b>Part No. 9151104C</b></p> <p>4 buttons camera control of two electric locks possibility of connecting additional switch</p>
		
<p><b>Part No. 9151104W</b></p> <p>10 W loudspeaker, IP69K 4 buttons control of two electric locks possibility of connecting additional switch</p>	<p><b>Part No. 9151104CW</b></p> <p>10 W loudspeaker, IP69K 4 buttons camera control of two electric locks possibility of connecting additional switch</p>	<p><b>Part No. 9151101K</b></p> <p>1 button keypad control of two electric locks possibility of connecting additional switch</p>
		



<b>Part No. 9151101CK</b> 1 button keypad camera control of two electric locks possibility of connecting additional switch	<b>Part No. 9151101CKW</b> 10 W loudspeaker, IP69K 1 button keypad camera control of two electric locks possibility of connecting additional switch	
--	--	--

		
<p><b>Part No. 9151101KW</b></p> <p>10 W loudspeaker, IP69K</p> <p>1 button</p> <p>keypad</p> <p>control of two electric locks</p> <p>possibility of connecting additional switch</p>	<p><b>Part No. 9151102R</b></p> <p>2 buttons</p> <p>possibility of connecting card reader</p> <p>control of two electric locks</p> <p>possibility of connecting additional switch</p>	<p><b>Part No. 9151102CR</b></p> <p>2 buttons</p> <p>camera</p> <p>possibility of connecting card reader</p> <p>control of two electric locks</p> <p>possibility of connecting additional switch</p>
		
<p><b>Part No. 9151102CRW</b></p> <p>10 W loudspeaker, IP69K</p> <p>2 buttons</p> <p>camera</p> <p>possibility of connecting card reader</p> <p>control of two electric locks</p> <p>possibility of connecting additional switch</p>	<p><b>Part No. 915101RP</b></p> <p>1 button, pictograms,</p> <p>possibility of connecting card reader</p> <p>control of two electric locks</p> <p>possibility of connecting additional switch</p>	<p><b>Part No. 9151101CRP</b></p> <p>1 button, pictograms, with camera,</p> <p>possibility of connecting card reader</p> <p>control of two electric locks</p> <p>possibility of connecting additional switch</p>



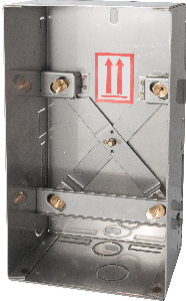

**2N® Helios IP Force** is designed for outdoor applications and requires no additional roof. W-including Part Nos. are intended for WAP pressure cleaning and extremely noisy environments (such as highways, etc.).

All **2N® Helios IP Force** units can be flush or wall mounted without requiring any additional accessories. Use the appropriate mounting box (see below) for plasterboard and hollow brick flush mounting.

## Flush Mounting Box

 A rectangular metal mounting box designed for installation in a brick wall. It features a front panel with two circular cutouts for mounting and a red square warning symbol with two upward-pointing arrows on the front face.	 A rectangular metal mounting box designed for installation in a plasterboard wall. It has a U-shaped profile with a central horizontal bar and a bottom flange for secure mounting.
<p><b>Part No. 9151001</b> Brick flush mounting box</p> <p>Dimension: 132 x 223 x 83 mm</p>	<p><b>Part No. 9151002</b> Plasterboard flush mounting box</p> <p>Dimension: 237 x 129 x 70 mm Hole: 237 x 118 mm</p>

## Internal Units



		
<p><b>Part No. 91378365</b></p> <p><b>2N® Indoor Touch - black</b></p> <p>The elegant internal touch panel, <b>2N® Indoor Touch</b>, is suitable for all <b>2N® Helios IP</b> intercoms. On the panel's display not only can you find out who is at the door, but also start a conversation with the visitor, open the lock or turn on the light in the entrance hall.</p>	<p><b>Part No. 91378365WH</b></p> <p><b>2N® Indoor Touch - white</b></p> <p>The elegant internal touch panel, <b>2N® Indoor Touch</b>, is suitable for all <b>2N® Helios IP</b> intercoms. On the panel's display not only can you find out who is at the door, but also start a conversation with the visitor, open the lock or turn on the light in the entrance hall.</p>	
		
<p><b>Part No. 91378366</b></p> <p><b>2N® Indoor Touch - black</b></p> <p>WiFi</p> <p>The elegant internal touch panel, <b>2N® Indoor Touch</b>, is suitable for all <b>2N® Helios IP</b> intercoms. On the panel's display not only can you find out who is at the door, but also start a conversation with the visitor, open the lock or turn on the light in the entrance hall.</p>	<p><b>Part No. 91378367</b></p> <p><b>2N® Indoor Touch - black</b></p> <p>WiFi + NFC</p> <p>The elegant internal touch panel, <b>2N® Indoor Touch</b>, is suitable for all <b>2N® Helios IP</b> intercoms. On the panel's display not only can you find out who is at the door, but also start a conversation with the visitor, open the lock or turn on the light in the entrance hall.</p>	<p><b>Part No. 91378368</b></p> <p><b>2N® Indoor Touch - black</b></p> <p>NFC</p> <p>The elegant internal touch panel, <b>2N® Indoor Touch</b>, is suitable for all <b>2N® Helios IP</b> intercoms. On the panel's display not only can you find out who is at the door, but also start a conversation with the visitor, open the lock or turn on the light in the entrance hall.</p>



## VoIP Telephones

	
<p><b>Part No. 91378357</b> Grandstream GXV3240 VoIP video telephone</p> <p>GXV3240 is the successor to the popular GXV3140 model, which allows comfortable video calls in the IP network. Touchscreen and keyboard control.</p>	<p><b>Part No. 91378358</b> Grandstream GXV3275 VoIP telephone</p> <p>GXV3275 is the successor to the popular GXV3175 model, which allows comfortable video calls in the IP network. Touchscreen control.</p>



## Electric Locks

		
<p><b>Part No. 932070E</b> BEFO 1211</p> <p>12 V / 600 mA</p>	<p><b>Part No. 932080E</b> BEFO 1221 with momentum pin</p> <p>12V / 600 mA</p> <p>For opening of the lock a short electrical impuls is sufficient, which unlocks the lock. Lock is then open until someone closes the door.</p>	<p><b>Part No. 932090E</b> BEFO 1211MB with mechanical blocking</p> <p>12V / 600 mA</p> <p>Enables mechanically close or open the lock. When opened, the lock is open all the time. When closed, it behaves as standart electrical lock.</p>



 **Tip**







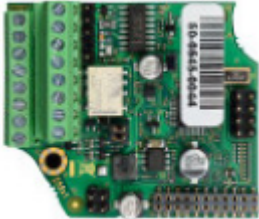
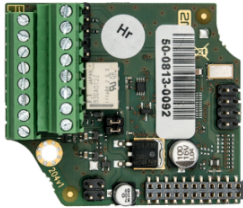
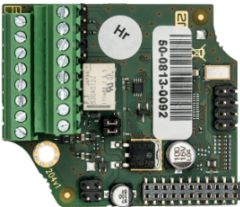

- FAQ: [Electric locks - Difference between locks in 2N® Helios IP accesories](#)





## Power Supply

		
<p><b>Part. No. 91378100</b> PoE injector - without cable</p> <p><b>Part. No. 91378100E</b> PoE injector - with EU cable</p> <p><b>Part. No. 91378100US</b> PoE injector - with US cable</p> <p>For power supply of intercom via <a href="#">ethernet</a> cable when PoE switch is not available.</p>	<p><b>Part No. 91341481E</b> Adapter 12 V / 2 A Stabilised 12 V / 2 A power supply needs to be used when no PoE is available.</p>	<p><b>Part No. 932928</b> 12 V transformer</p> <p>For external power supply of the lock with 12V AC voltage.</p>

## Additional Modules

		
<p><b>Part No. 9151010</b> Additional switch with normally open/closed contact and 12 V switched output. Includes tamper switch.</p> <p>Enables control of a secondary device, passive time unlimited switching up to 48 V / 2 A or active switch 12 V / 700 mA. Also includes tamper switch to signal opening of the front panel.</p>	<p><b>Part No. 9151011</b> Includes tamper switch.</p> <p>Internal RFID card reader 125 kHz for installation in <b>2N<sup>®</sup> Helios IP Force</b> intercoms. Allows the use of EM4100, EM4102 and HID Proximity cards. Another two switches, two logical inputs and a Wiegand interface are available. It is compatible with the <b>2N<sup>®</sup> Helios IP Force</b> two-button and pictogram models. It also includes a security switch to signal when the front panel is opened.</p>	<p><b>Part No. 9151016</b> Includes tamper switch.</p> <p>Internal RFID card reader 13.56 MHz for installation in <b>2N<sup>®</sup> Helios IP Force</b> intercoms. Allows the use of Mifare, iClass, DESFire and other standards. Two switches, two logical inputs and a Wiegand interface are available. It is compatible with the <b>2N<sup>®</sup> Helios IP Force</b> two-button and pictogram models. It also includes a security switch to signal when the front panel is opened.</p>
		
<p><b>Part No. 9151017</b> Internal RFID card reader 13.56 MHz NFC for <b>2N<sup>®</sup> Helios IP Force</b> mounting.</p>	<p><b>Part No. 9159010</b> Security Relay</p> <p>A handy add-on that significantly enhances door entry security as it prevents tampering with the intercom and forced opening of the lock. To be installed between intercom and lock, powered by the intercom.</p>	<p><b>Part No. 9159011</b> Wiegand Isolator</p> <p>The <b>2N<sup>®</sup> Helios IP Wiegand I</b> isolator is designed for galvanic isolation of two devices separately power supplied and interconnected via the Wiegand bus. The <b>2N<sup>®</sup> Helios IP Wiegand Isolator</b> protects the interconnected devices against communication errors and/or damage.</p>

		
<p><b>Part No. 9137410E</b> External IP Relay - 1 output</p> <p>Standalone IP device which can be controlled by <a href="#">HTTP</a> commands sent by Helios IP intercom, which can thus control devices on unlimited distance.</p>	<p><b>Part No. 9137411E</b> External IP Relay - 4 outputs, PoE</p> <p>Standalone IP device which can be controlled by <a href="#">HTTP</a> commands sent by Helios IP intercom, which can thus control devices on unlimited distance.</p>	<p><b>Part No. 9134165E</b> RFID card, 125 kHz</p> <p>EM4100</p>
		
<p><b>Part No. 9134166E</b> RFID key fob, 125 kHz</p>	<p><b>Part No. 9137420E</b> External RFID card reader for connection to a PC using a USB interface. Suitable for system management and the addition of EM41xx cards via the PC application, <b>2N® Helios IP Manager.</b></p>	<p><b>Part No. 9159050</b> Induction Loop</p>
		

<p><b>Part No. 9134173</b> Mifare RFID card, 13.56 MHz</p>	<p><b>Part No. 9134174</b> Mifare RFID card, 13.56 MHz</p>	<p><b>Part No. 9159014EU/US/UK</b></p> <p><b>2N® 2Wire</b></p> <p>(set of 2 adaptors and power source for EU/US/UK)</p> <p>The <b>2N® 2Wire</b> converter allows you to use existing wiring (2 wires) from your original door bell or door intercom to connect any IP device. You don't have to configure anything, and you only need one <b>2N® 2Wire</b> unit at each end of the cable and a power source connected to at least one of these units. The <b>2N® 2Wire</b> unit then provides <a href="#">PoE</a> power not only to the second converter, but also to all other connected IP end devices.</p>
		
<p><b>Part No. 9159013</b></p> <p>Exit button</p> <p>(suitable for Internal RFID card reader or Security relay)</p> <p>A button for connection to a logic input for opening a door inside a building.</p>	<p><b>Part No. 9159012</b></p> <p>Magnetic door contact</p> <p>(suitable for Internal RFID card reader)</p> <p>Set for installation on a door, enabling the status of door opening to be ascertained. Used when the intercom is used for door protection, to detect when the door is not closed or forced open.</p>	<p><b>Part No. 9159030</b></p> <p>External RFID card reader, 125 kHz</p> <p>Secondary reader for connection to an internal reader. Allows control of card entry from both sides of the door. IP67 cover, also suitable for exteriors. Reads EM4100 and EM4102 cards.</p>
		

<b>Part No. 9154004</b> Water-proof metal button  (suitable for Internal RFID card reader)		
---	--	--

✔ **Tip**

- For more accessories and particular advice please contact your local distributor of 2N products.

✔ **Tip**

- FAQ: [Induction loop - How to connect it with 2N® Helios IP](#)

## 1.2 Terms and Symbols

The following symbols and pictograms are used in the manual:

 **Safety**

- **Always abide** by this information to prevent persons from injury.

 **Warning**

- **Always abide** by this information to prevent damage to the device.

 **Caution**

- **Important information** for system functionality.

 **Tip**

- **Useful information** for quick and efficient functionality.

 **Note**

- Routines or advice for efficient use of the device.

---

# 2. Description and Installation

---

Here is what you can find in this section:

- [2.1 Before You Start](#)
- [2.2 Mechanical Installation](#)
- [2.3 Electric Installation](#)
- [2.4 Extending Module Connection](#)
- [2.5 Button Tags](#)



## 2.1 Before You Start

### Product Completeness Check

---

Before you start please check the contents of your **2N® Helios IP Force** delivery:

- 1× **2N® Helios IP Force**
- 1× frame (of the corresponding colour)
- 1× Torx 10 / Torx 20 double-ended wrench
- Bushings (enclosed):
  - 1× big two-hole sealed bushing with nut
  - 1× spare sealing for big bushing for a thick cable, one hole
  - 1× big blank with nut
  - 1× small bushing with nut
  - 1× bushing plug, big size
  - 2× bushing plugs, small size
- 1× **2N® Helios IP Force** Installation Manual
- 1× mounting template
- 1× A5 transparent name plate foil
- 1× spare name tag
- 4× (5 × 90) mm screws
- 4× "intelligent" (8 × 50) mm dowels

## 2.2 Mechanical Installation

### Mounting Type Overview

Refer below for a list of mounting types and necessary components.

#### Flush Mounting – Classic Bricks

##### What You Need:

- A precisely cut hole or, optionally, the brick flush mounting box, Part No. 9151001
- Hole: (132 × 223 × 83) mm (with flush mounting box)
- Hole: (112 × 220 × 70) mm (without flush mounting box)

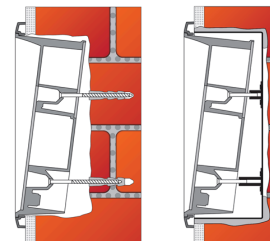

#### Flush Mounting – Thermally Insulated Wall

##### What You Need:

- Longer screws (depending on the thermal insulation thickness)
- Hole: (112 × 220 × 70) mm

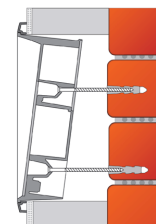

#### Flush Mounting – Hollow Bricks

##### What You Need:

- Brick flush mounting box, Part No. 9151001
- Hole: (132 × 223 × 83) mm

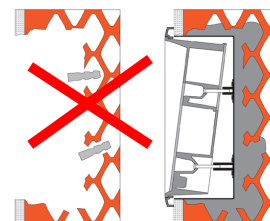

#### Flush Mounting – Plasterboard Wall

##### What You Need:

- Plasterboard flush mounting box, Part No. 9151002
- Hole: 118 × 235mm



## Wall Mounting (concrete and steel structures, entry barrier columns, etc.)

### What You Need:

- Just your **2N® Helios IP Force** unit

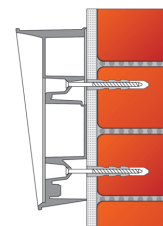

### Caution

- The warranty does not apply to the product defects and failures arisen as a result of improper mounting (in contradiction herewith). The manufacturer is neither liable for damages caused by theft within an area that is accessible after the attached electric lock is switched. The product is not designed as a burglar protection device except when used in combination with a standard lock, which has the security function.
- When the proper mounting instructions are not met, water might get in and destroy the electronics. It is because the intercom circuits are under continuous voltage and water infiltration causes an electro-chemical reaction. The manufacturer's warranty shall be void for products damaged in this way!

## Common Mounting Principles

### Tip

- Select flush mounting where possible to make your product elegant looking, more vandal resistant and more secure.
- You can purchase the flush mounting box in advance and hire an installation professional to make the basic installation work. Moreover, the mounting box helps you align the intercom vertically (with a deviation of up to 2°).

### Caution

- Make sure that the dowel holes have the required diameter. If the diameter is too large, the dowels may get loose. Use some suitable building adhesive to keep the dowels in place.
- Make sure that the hole depth is sufficient too! The dowel length is 50 mm and the screw length is 90 mm.
- Remember that dowels of poor quality may easily get loose and fall out of the wall!
- Stainless steel screws are used for the **2N® Helios IP Force** assembly. Other screws than stainless steel ones corrode soon and may aesthetically deteriorate the surrounding environment!
- Having removed the front panel, make sure that no dirt gets inside the product (especially onto the sealing surface and microphone sound guides).

**i Note**

- The microphone sound guides are normally loose after the front panel is removed! The screw is only used as a fall-out protection during installation.

## Flush Mounting – Classic Bricks

If you use the brick flush mounting box, follow the instructions included in the box. If you do not use the mounting box, follow the instructions below:

1. Make a hole using the template. Suppose that all the required cables have been carried into the hole.
2. Unpack the frame, put the intercom inside and place the set onto the hole to make sure that the hole is deep enough and the uneven edge is perfectly covered with the frame.
3. Make sure that the dowel holes are drilled accurately! You will not be able to align considerable inaccuracies with this way of mounting! Push or hammer the enclosed dowels into the drilled holes. Use some suitable building adhesive if the dowels are too loose.
4. Remove the front panel from the intercom.
5. Select the holes for cable supply. Insert the blanks into the other holes. Apply the cable bushings or a suitable sealant to prevent penetration of insects or water. You can also insert the small bushing in the intercom bottom hole.
6. Put the frame on the intercom.
7. Place the intercom into the hole while introducing the cables. Leave some of the cables inside the unit as a reserve and the rest under the intercom bottom.
8. Insert the enclosed screws in the lateral mounting holes making sure they have penetrated into the dowels. Tighten all the screws properly. Tip: The screw tightening sequence may affect the intercom position.
9. We recommend to seal the frame – wall gap with a silicone or another sealant to avoid wall dampening as a result of water leakage.
10. Do not complete mounting until you have finished electrical installation.

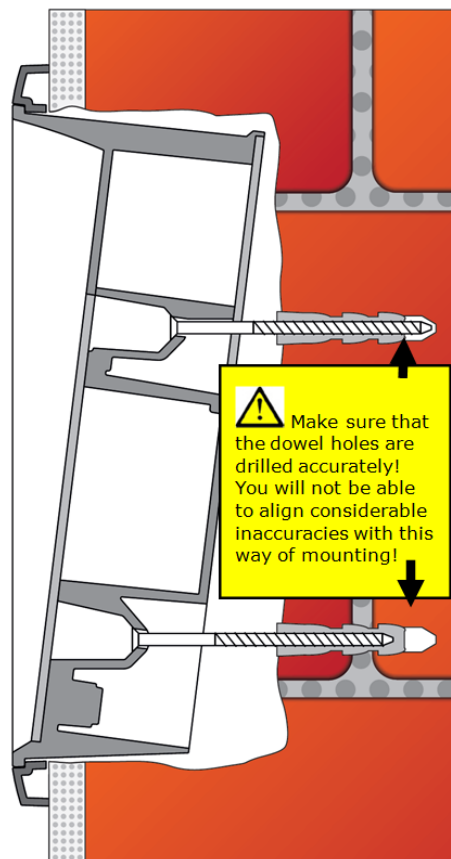

Be sure keep strictly the hole dimensions while mounting the device into classic bricks without the flush mounting box as shown in the figure below.

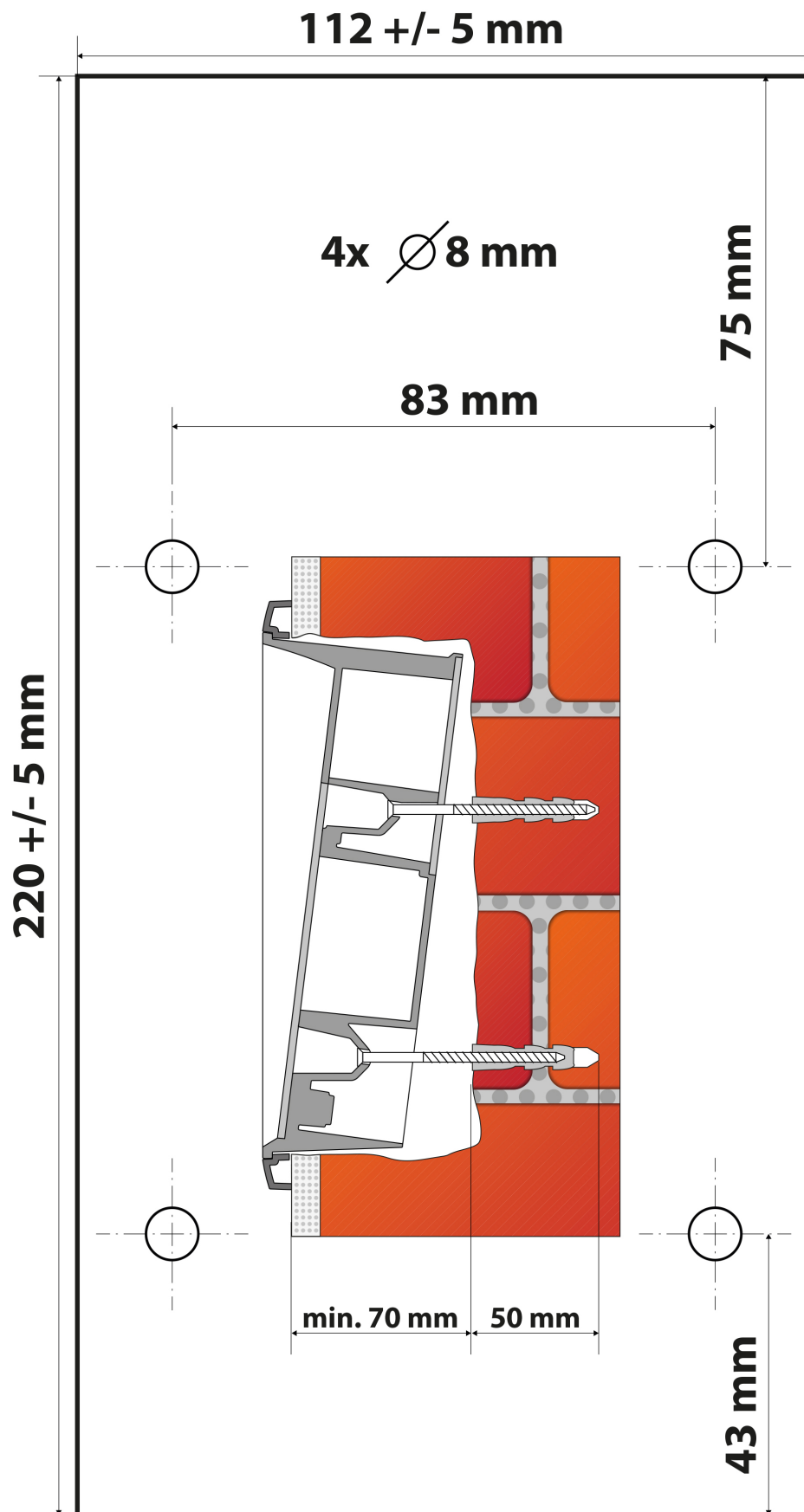

## Flush Mounting – Thermally Insulated Wall

Cut out the thermal insulation layer using the template (the same as for classic brick wall).

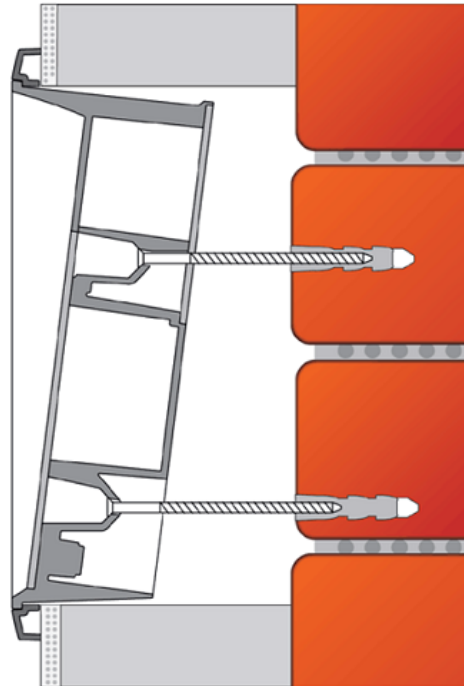

### Caution

- The hole depth depends on the insulation layer thickness. If the insulation layer is rather thick, you may need longer screws! If there are hollow bricks under the insulation, make sure that your screws pass through the whole dowel (50 mm) and fix the dowel reliably.
- Make sure that the dowel holes have the required diameter. If the diameter is too large, the dowels may get loose. Use some suitable building adhesive to keep the dowels in place.
- Make sure that the hole depth is sufficient too! The dowel length is 50 mm and the screw length is 90 mm.

Suppose that all the required cables have been carried into the drilled hole. Now follow the instructions applicable for classic brick flush mounting. However, remember that thermally insulated walls show less strength than classic brick walls.

## Flush Mounting – Plasterboard

Use the plasterboard flush mounting box and follow the instructions included therein.

## Flush Mounting – Hollow Bricks

Suppose you intend to install your **2N® Helios IP Force** unit into a wall made of hollow bricks. Note that the external side of the bricks gets damaged by cutting and the dowels cannot practically be fixed into the thin internal part of the bricks. Therefore, use the brick flush mounting box and follow the instructions included therein.

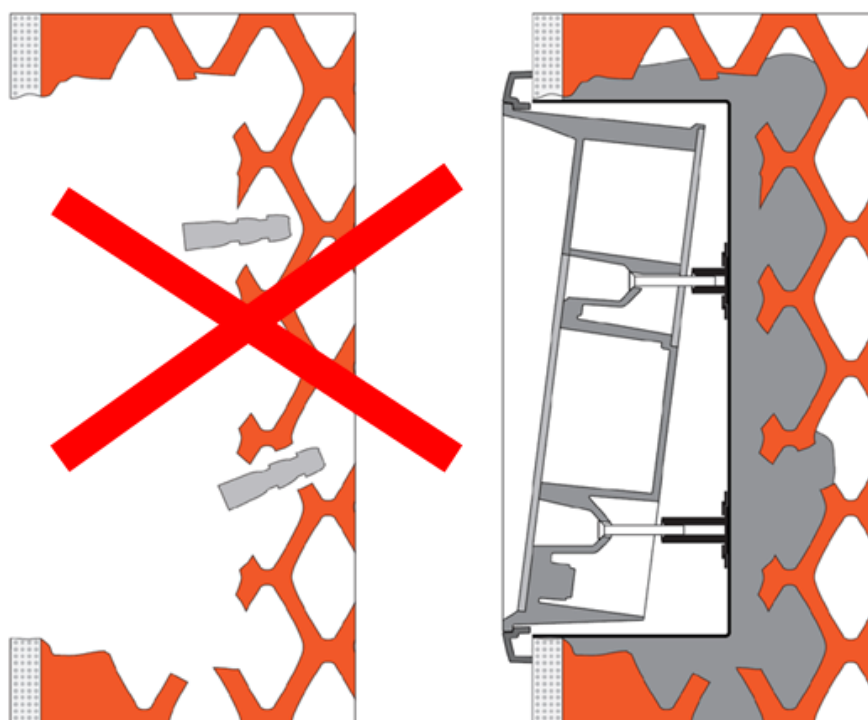

## Wall Mounting

Wall (surface) mounting is used where flush mounting is inapplicable (in concrete and steel structures, entry barrier columns, etc.). The frame is not used.

### **Caution**

- Wall mounting may be a problem where vandals may destroy the unit (in public garages, e.g.). Therefore, use steel fixing elements instead of the dowels and screws included in the delivery.
- Be sure to insert plugs into unused bushing holes to avoid water leakage during facade cleaning, for example. Never leave the holes open for even a short time (one day delay between mounting and cable connection, e.g.).



### ⚠ Warning

- Eliminate the risk of accident! Wall mounting is not suitable for narrow passages or places where people's attention may be distracted. The manufacturer shall not be liable for injuries incurred as a result of unsafe mounting!

1. Select position with respect to the supply cables. Where the cables are installed inside a structure or wall, use the hole at the intercom bottom.
2. Drill holes of the depth of 70 mm for dowels in the wall as shown in the figure. Push or hammer the enclosed dowels into the drilled holes. Use some suitable building adhesive if the dowels are too loose. Use fixing elements of your own for steel structure surface mounting (metric screws + nuts, e.g.).
3. Remove the front panel from the intercom.
4. Select the holes for cable supply. Select and mount the bushings depending on the cables: 2-hole bushing or 1-hole bushing or both. Insert the blanks in the other holes.
5. Put the intercom on the wall/structure while introducing cables inside. Leave some of the cables inside the unit as a reserve. Insert the plugs in the unused bushings and tighten the bushing nuts carefully.
6. Do not complete mounting until you have finished electrical installation. Where cables lead along the surface, use the bushings included in the delivery.

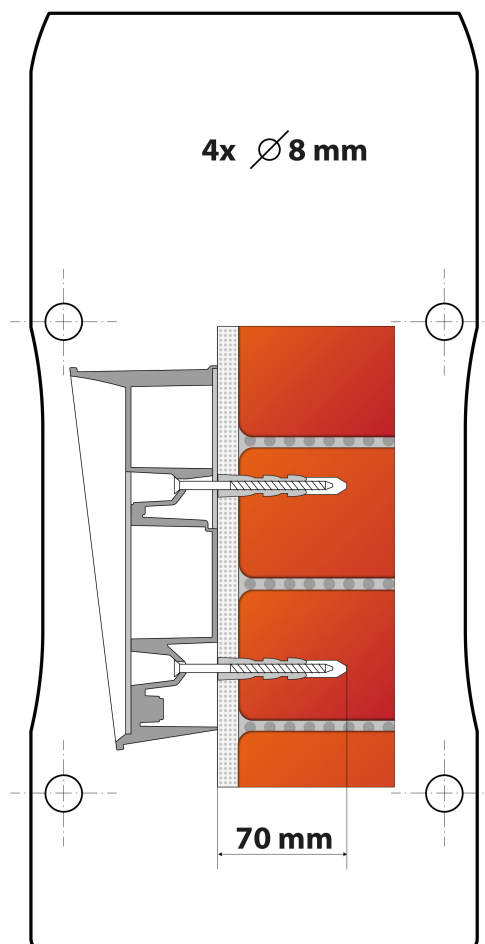

## Use of Cable Bushings

The cable bushings included in the **2N® Helios IP Force** delivery are designed for the following cables:

- Big bushing: for two cables of the diameter of 5–6 mm (UTP cable), or, upon insert replacement, for one thick cable/tube of the diameter of up to 14 mm.
- Small bushing: for one cable of the diameter of 5–8 mm.

### ✓ Tip

- Even a LAN cable including the RJ-45 connector can go through the big bushing. See below for instructions.

## How to Pull a RJ-45 Terminated Cable through a Bushing

1. Unscrew the big bushing nut completely.

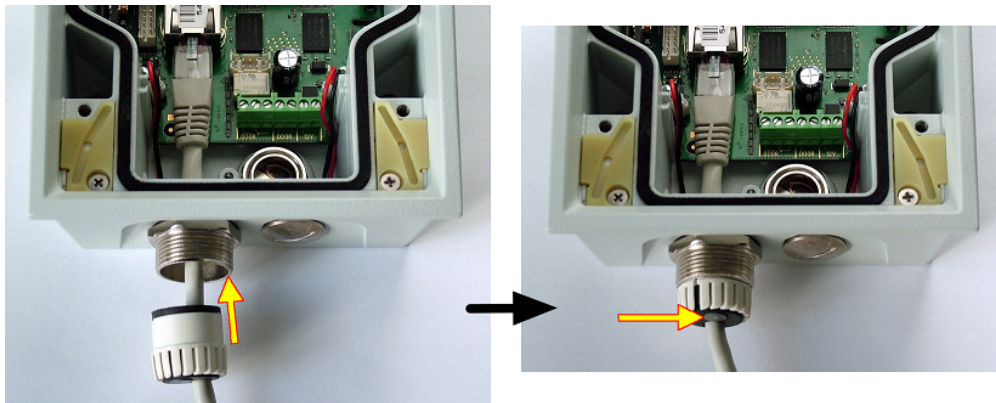

2. Remove the sealing including the cover from the bushing. Cut either of the components as shown in the figures.

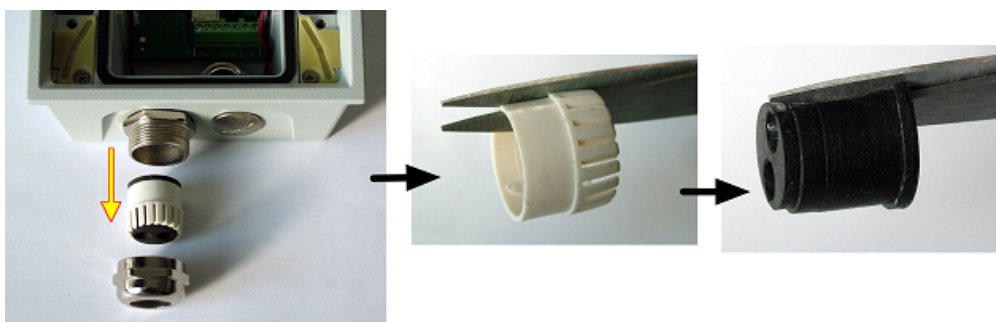

3. Put the bushing nut on the cable and insert the sealing.

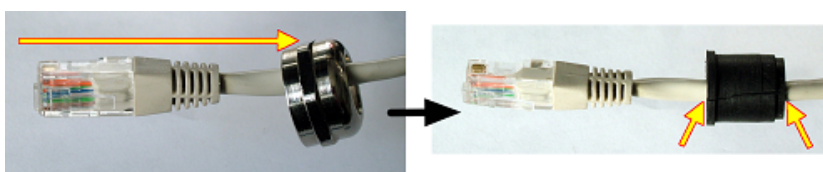

4. Replace the cover onto the sealing.



5. Pull the cable connector through the bushing body into the intercom and clip it into the motherboard connector.

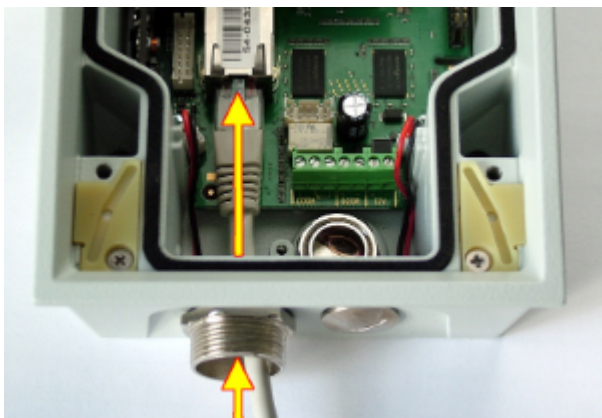

6. Move the sealing including the cover along the cable as far as the bushing body, or add a plug if necessary.

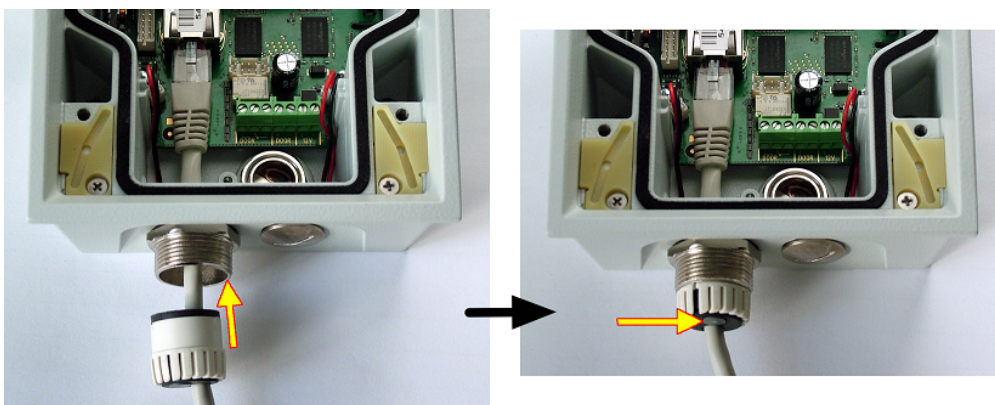

7. Replace and tighten the nut.

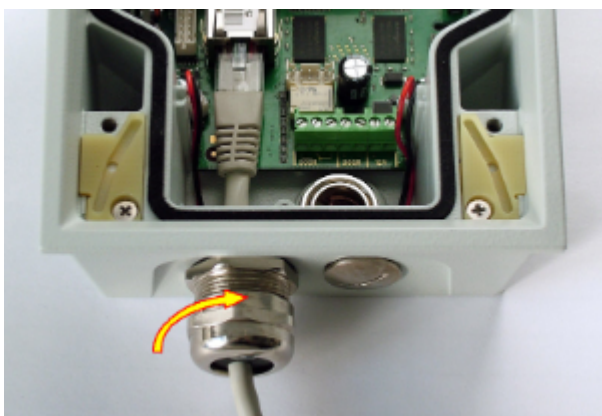

## 2.3 Electric Installation

This subsection describes how to connect **2N® Helios IP Force** into your Local Area Network (LAN) and how to connect supply voltage and the electric lock.

### PCB Connectors

---

Picture shows the lay-out of connectors on the **2N® Helios IP Force** printed circuit board (PCB). Cables, accessories and other system components are connected to connectors X1 through X22.

Connectors description:

- **X1** – Loudspeaker
- **X2** – Button 2
- **X3** – Button 3
- **X4** – Camera module
- **X5** – Button 1
- **SW1** – Reset button (555v3 version only)
- **X6** – Configuration jumpers
- **X7** – Induction loop output
- **X8** – Extending module (RFID card reader or additional switch)
- **X10** – Buttons 1 through 4
- **X11** – LAN
- **X12** – Servicing connector
- **X13** – Keypad module
- **X15** – Left-hand microphone
- **X16** – Right-hand microphone
- **X17** – Relay NO and NC contact max. 30 V / 1 A AC/DC
- **X18** – Switched output 9 up to 13 V DC depending on power supply (PoE: 9 V; adaptor: power supply voltage minus 1 V), max 700 mA
- **X19** – Power input 12 V  $\pm$ 15 % / 2 A DC
- **LED1/2** – System status indicators
- **LED3** – LAN connection activity indicator

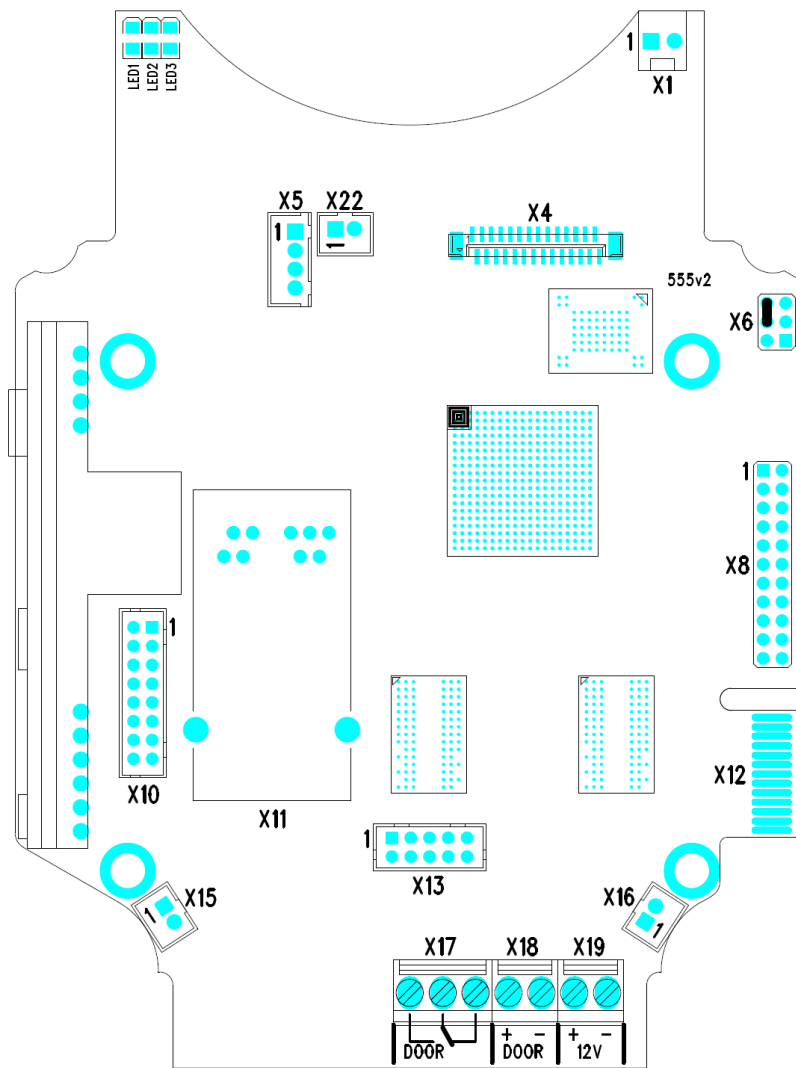

**Figure: 2N<sup>®</sup> Helios IP Force Connectors, PCB Version 555v2**

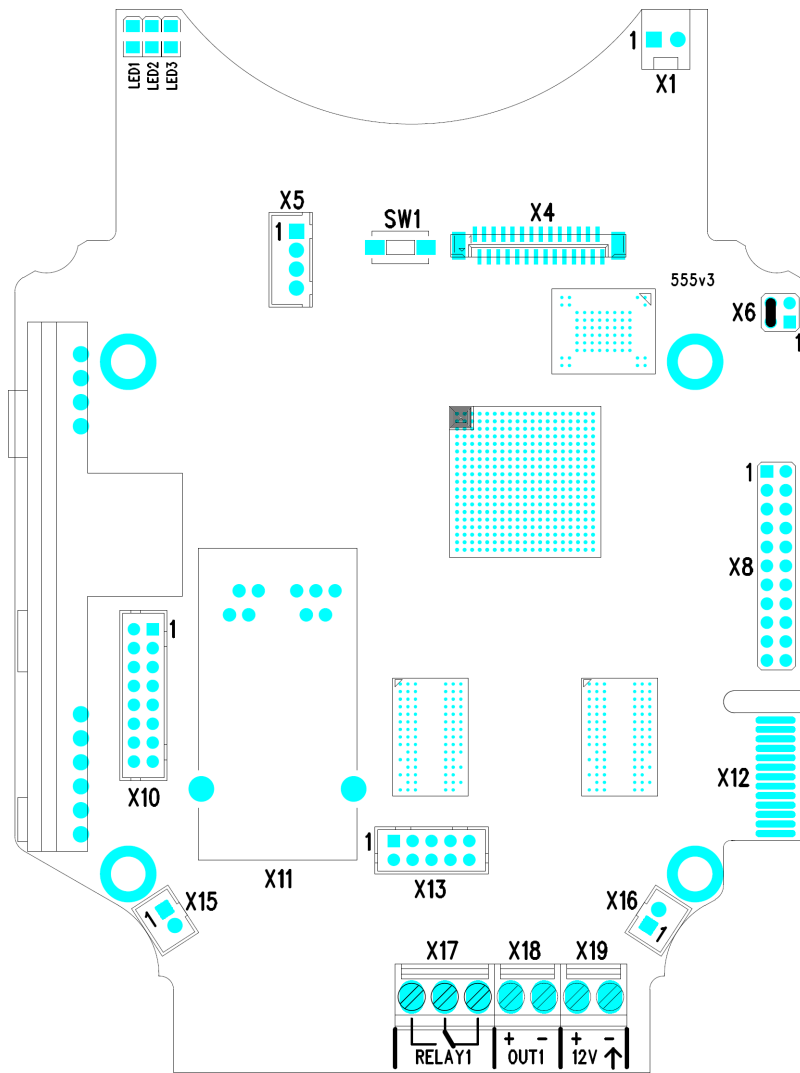

**Figure: 2N<sup>®</sup> Helios IP Force Connectors, PCB Version 555v3**

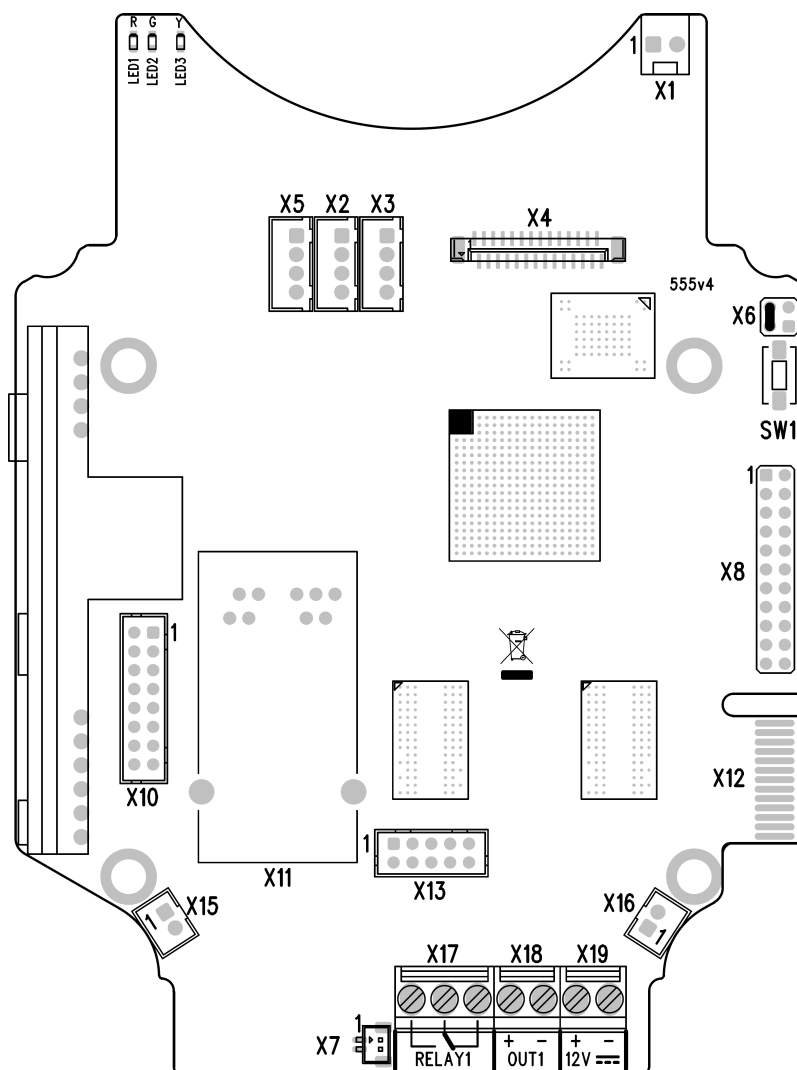

Figure: 2N® Helios IP Force Connectors, PCB Version 555v4

## LAN Connection

**2N® Helios IP Force** is connected to the LAN via a RJ-45 terminated (connector X11) UTP/STP cable (of category Cat 5e or higher). The system is equipped with the Auto-MDIX function and so both the straight and crossed cable versions can be used.

## External Power Supply Connection

**2N® Helios IP Force** can be fed either from an external 12 V  $\pm 15\%$  / 2 A DC power supply or from the LAN equipped with the PoE 802.3af supporting network elements.

### External Power Supply

An external 12 V power supply is connected to terminal block X19. Use a 12 V  $\pm 15\%$  DC power source dimensioned to current intake of 2 A at least (Part No. 91341481E) to ensure a reliable function of your device.

## PoE Supply

**2N® Helios IP Force** is compatible with the PoE 802.3af (Class 0 – 12.95 W) technology and can be supplied directly from the LAN via compatible network elements. If your LAN is incompatible, insert the PoE injector, Part No. 91378100E/US, between **2N® Helios IP Force** and the nearest network element.

## Electric Lock Connection

---

**2N® Helios IP Force** is equipped with an electrically isolated relay switch with NO and NC contacts (terminal block X17, max. 30 V / 1 A AC/DC) and 9 up to 13 V DC depending on power supply (PoE: 9 V; adaptor: power supply voltage minus 1 V), max 700 mA switched output (terminal block X18), to which a standard electric lock or another compatible electrical appliance can be connected.

### Note

- Devices with PCB version 555v3 and higher provides independent control of 12 V switched output (terminal block X18) and relay switch (terminal block X17). Devices with PCB version 555v2 have both outputs switched simultaneously.

## Factory Default Resetting (PCB version 555v3)

---

For resetting device to default settings press and hold SW1 button. Wait for the first sound signalization and then release the button. If you press the button for short time device will reboot only. SW1 button is available in devices with PCB version 555v3 and higher. For devices with PCB version 555v2 see procedure below.

## Factory Default Resetting (PCB version 555v2)

---

1. Disconnect the device from the power supply.
2. Move the short-circuit jumper on connector X6 into the **Default setup** position. Configuration jumpers (X6) are located in the right-hand upper corner of the PCB.
3. Reconnect the power supply and wait for a start signalling sound.
4. Disconnect the device from the power supply.
5. Move the short-circuit jumper on connector X6 into the **Normal operation** position.
6. Reconnect the power supply. The device will be reset to factory default.



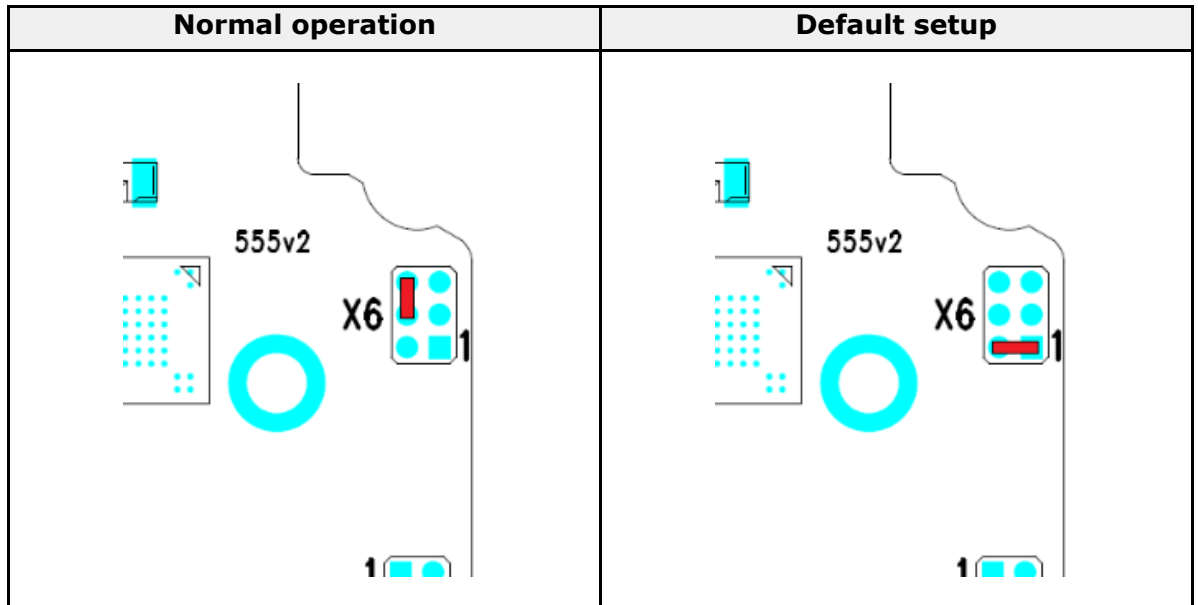

**Figure:** Configuration jumpers X6, PCB version 555v2

## Mounting Completion

1. Having connected all the wires, make sure that the bushings, if used, are tightened properly and the RJ-45 connector is inserted in the PCB connector.
2. Replace the front cover carefully. Make sure that the connector is inserted correctly and the wires inside the device leave enough space for the board if you are installing a four-button board. Tighten the four screws thoroughly with the wrench enclosed (Torx 20) to make the panel fit tightly to the metal chassis.

### Caution

- Properly installed intercom is waterproof. An incorrect mounting may compromise the intercom watertightness. Water leakage may damage the electronic part of the system.
- Stainless steel screws are used for the **2N<sup>®</sup> Helios IP Force** assembly. Other screws than stainless steel ones corrode soon and may aesthetically deteriorate the surrounding environment!

## Available Switches

Location	Name	Description
<b>Basic Unit</b>	Relay 1	<b>Passive relay switch:</b> NO and NC contacts, up to 30 V / 1 A AC/DC
	Output 1	<b>Active switch output:</b> 9 up to 13 V DC depending on power supply (PoE: 9 V; adaptor: power supply voltage minus 1 V), max 700 mA
<b>Additional Switch*</b>  (Part No. 9151010)	Relay 2	<b>Passive relay switch:</b> NO and NC contacts, up to 30 V / 1 A AC/DC
	Output 2	<b>Active switch output:</b> 9 up to 13 V DC depending on power supply (PoE: 9 V; adaptor: power supply voltage minus 1 V), max 700 mA
<b>Internal RFID Card Reader 125 kHz*</b>  (Part No. 9151011)	Relay 1 (Card Reader),	<b>Passive relay switch:</b> NO and NC contacts, up to 30 V / 1 A AC/DC
	Output 1 (Card Reader)	<b>Active switch output:</b> 9 up to 13 V DC depending on power supply (PoE: 9 V; adaptor: power supply voltage minus 1 V), max 700 mA
<b>Internal RFID Card Reader 13.56 MHz*</b>  (Part No. 9151016)	Relay 1 (Card Reader),	<b>Passive relay switch:</b> NO and NC contacts, up to 30 V / 1 A AC/DC
	Output 1 (Card Reader)	<b>Active switch output:</b> 9 up to 13 V DC depending on power supply (PoE: 9 V; adaptor: power supply voltage minus 1 V), max 700 mA

Only one module marked by \* can be used.

## 2.4 Extending Module Connection

**2N® Helios IP Force** allows to connect following extending modules:

- [Additional Switch](#)
- [Internal RFID Card Reader 125 kHz](#)
- [Internal RFID Card Reader 13.56 MHz](#)
- [Security Relay](#)
- [Wiegand Isolator](#)

### Additional Switch

The **Additional Switch** (Part No. 9151010) is used for extending the number of outputs. This extending module is intended for mounting into the **2N® Helios IP Force** main unit and is compatible with the basic units with Part No. 915110xxxxx. If the Additional Switch is installed, it is not possible to install Internal RFID Card Reader.



#### Function:

The **2N® Helios IP Force** Additional Switch adds two additional switches and a tamper switch to the **2N® Helios IP Force** basic unit. The purpose of the tamper switch is to signal any unauthorised opening of the intercom (to prevent a theft, e.g.). It is recommended to use the tamper switch.

#### Tip

- FAQ: [Tamper switch - How to install it into the 2N® Helios IP Force](#)

#### Specifications:

- Passive switch: NO and NC contacts, up to 30 V / 1 A AC/DC
- Active switch output: 9 V (Using PoE) or power supply voltage minus 1 V, from 9 to 13 V max. 700 mA DC
- Tamper switch: 24 V / 50 mA AC/DC

## Module mounting:

1. Switch off the intercom.
2. Remove the front panel from the intercom.
3. According to your model
  - a. If you are mounting the switch into a two-nameplate model, demount the button PCB (1) and remove the right-hand bottom spacer (there are four PCB fitting spacers altogether).
  - b. If you are mounting the switch into a keypad model, take the keypad out of the holder. Demount the right-hand keypad holder - beam with a pin (8) – remembering its position. Demount the right-hand bottom spacer. Do not disconnect the keypad cable!
  - c. If you are mounting the switch into a model other than the two ones mentioned in items 3a and 3b above, remove the right-hand bottom screw from the main board.
4. Now screw the enclosed 12 mm spacer (5) into the vacated main board slot.
5. Mount the enclosed plastic support (6) onto the switch board bottom side.
6. Put the switch board (4) in the main board connector making sure that the screw hole is directly above the spacer.
7. According to your model
  - a. If you are mounting the switch into a two-nameplate model, fit the switch board with the enclosed 10.5 mm spacer (3) and reinstall the button PCB (1).
  - b. If you are mounting the switch into a keypad model, reinstall the beam (8) of the keypad holder (the slot is on top). Insert the enclosed 4.5 mm washer (9) between the beam and the switch board, fitting the assembly with the 15 mm screw enclosed (7).
  - c. If you are mounting the switch into a model other than the two ones mentioned in items 7a and 7b, fit the switch board with the original 6 mm screw (2).
8. If you want to use the tamper switch, insert the tamper board (9) in the connector located in the right-hand bottom part of the switch board (4). As the tamper switch shares the relay output (NO and NC) terminals, you cannot use the RELAY2 output with the tamper switch together.
9. Place front panel back and tighten all four screws.

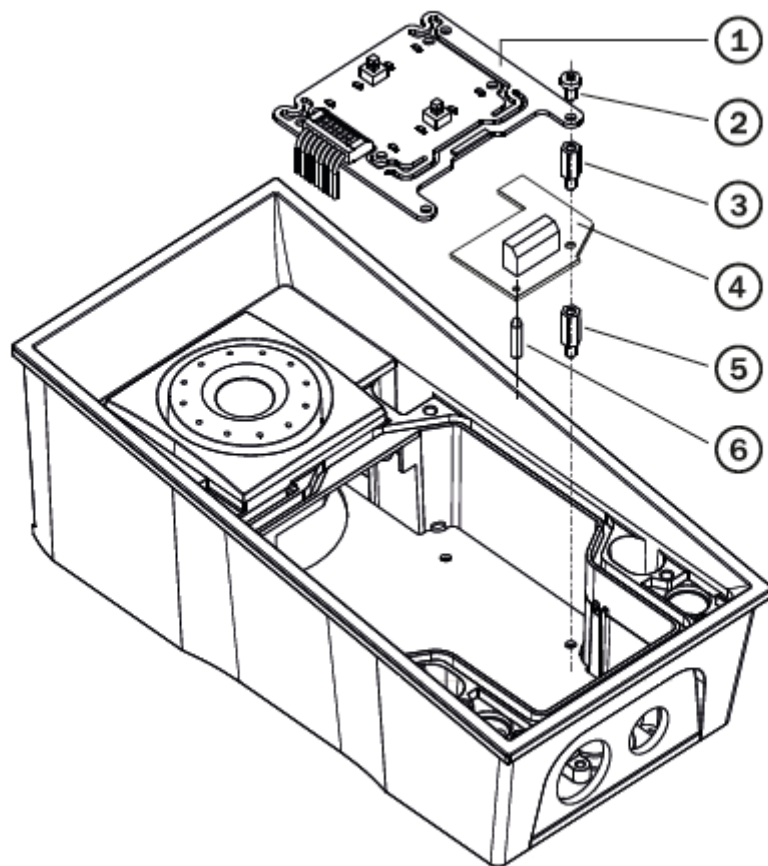

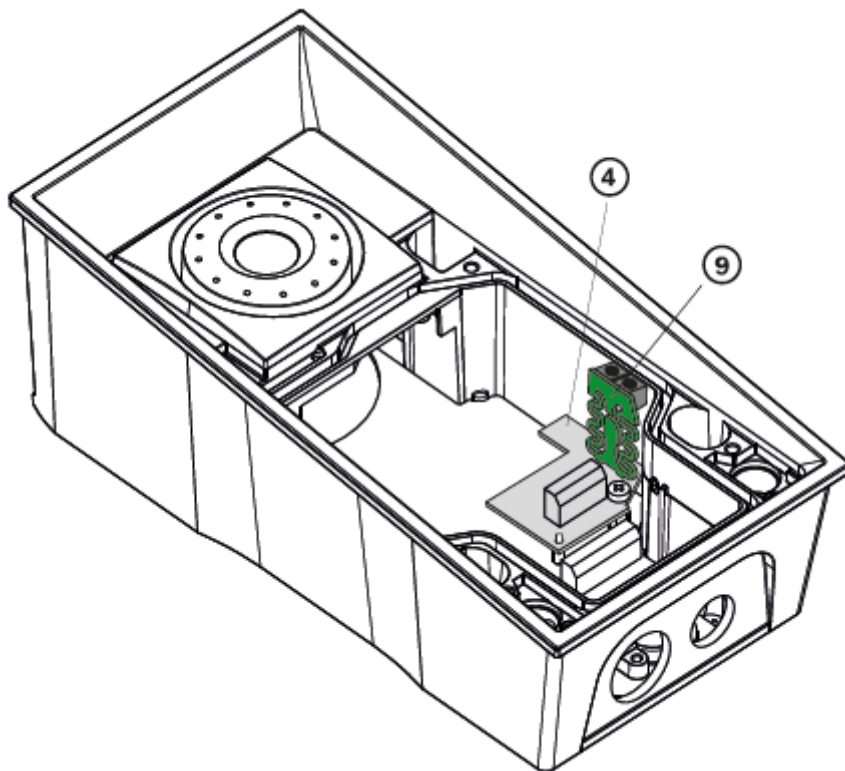
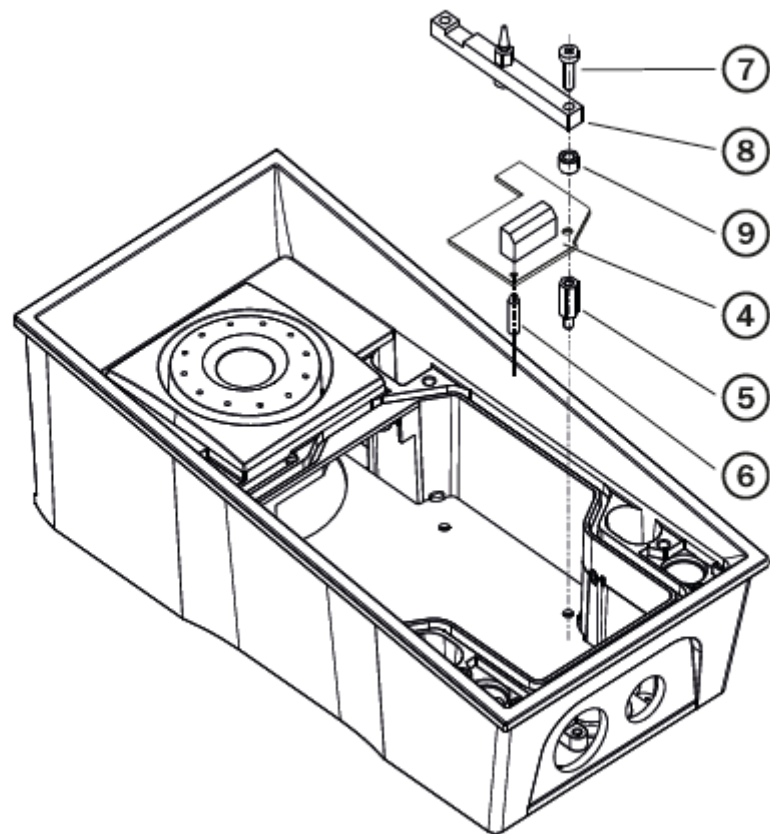

## Module settings:

Refer to the **2N® Helios IP Configuration Manual** for details.

## Connection:

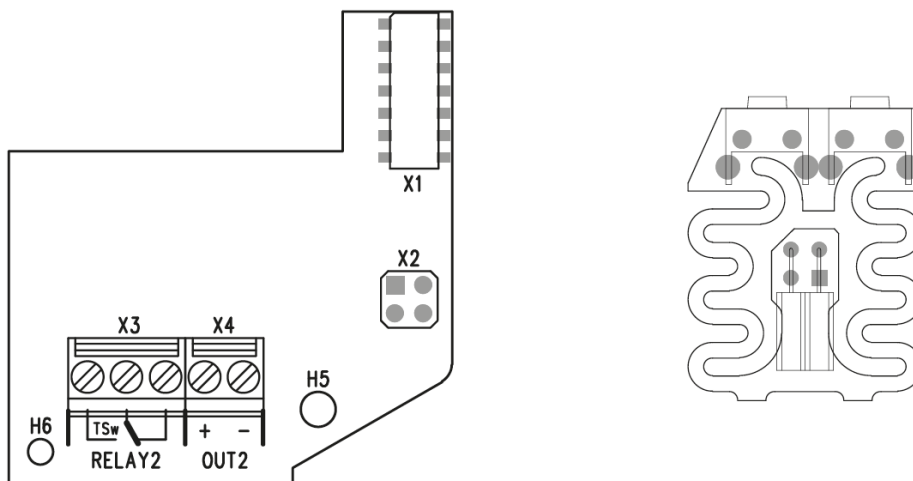

## Internal RFID Card Reader 125 kHz

The **Internal RFID Card Reader 125 kHz** (Part No. 9151011) is used for reading RFID card Ids in the 125 kHz band. This module is intended for mounting into the **2N® Helios IP Force** model 9151102CR, 9151102R, 9151101CRP and 9151101RP. These models have an window, which is necessary for antenna operation. If the Internal RFID Card Reader is installed, it is not possible to install the Additional Switch.

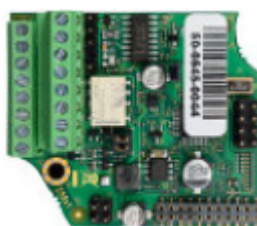

## Function:

The **2N® Helios IP Force** Internal RFID Card Reader adds two logical inputs, two additional switches and a tamper switch to the **2N® Helios IP Force** basic unit.

The purpose of the tamper switch is to signal any unauthorised opening of the intercom (to prevent a theft, e.g.). It is recommended to use the tamper switch.

 **Tip**

- FAQ: [Tamper switch - How to install it into the 2N<sup>®</sup> Helios IP Force](#)

## Specifications:

### Card reader

- Compatible with EM4100 / EM4102 / HID<sup>®</sup> Prox RFID cards
- Operating frequency: 125 KHz
- Minimum reading distance: 10 mm above **2N<sup>®</sup> Helios IP Force** cover

### Relay output

- Switching contact
- 30 V / 2A AC/DC

### Active output

- 12 V / 700 mA transistor switched output

### Logical inputs

Active mode – requires external voltage (JP2 jumper OFF)

- $U_{IN-ON} = \text{min } +2.5 \text{ V}$
- $U_{IN-OFF} = \text{max } +1.5 \text{ V}$
- $U_{IN \text{ max}} = +48 \text{ V}$
- $I_{IN} (U_{IN} +48 \text{ V}) = \text{max } 1 \text{ mA}$

Passive mode – requires external contact only (JP2 jumper ON)

- $U_{OUT} = \text{approx. } 8.3 \text{ V}$
- $I_{LOOP} = \text{approx. } 0.5 \text{ mA}$

### Signalling output

- Internal red LED under reader window

### WIEGAND interface

- Off/Input/Output (as programmed)



## Mounting guide:

1. Switch off the intercom.
2. Remove the front panel (7) from the intercom.
3. Mount antenna board (8). Use two enclosed self tapping screws (9).
4. Plug enclosed cable (11) to the antenna board connector.
5. Demount a button PCB (1). Don't disconnect its cable!
6. There will stay four spacers after the switch board removal. Dismount the bottom right one.
7. There are two short metal spacers enclosed to the reader. Take a longer one (5), 12 mm long. Screw it into the free hole.
8. Plug an enclosed plastic support (6) to the reader board from the bottom side.
9. Put the reader board (4) in the main board connector making sure that the mounting hole is directly above the spacer.
10. Screw in a remaining metal spacer (3), 10.5 mm long.
11. Fit the button PCB (1) back to its position using original bolts (2).
12. If you want to use the tamper switch (to detect unauthorized opening the case, as a theft protection), insert the tamper board (10) in the connector located in the right-hand bottom part of the reader board (4). As the tamper switch shares the relay output (NO and NC) terminals, you cannot use the RELAY2 output with the tamper switch at the same time.
13. Plug the antenna cable (11) to its connector at the reader board (4).
14. Place front panel back and tighten all four screws.

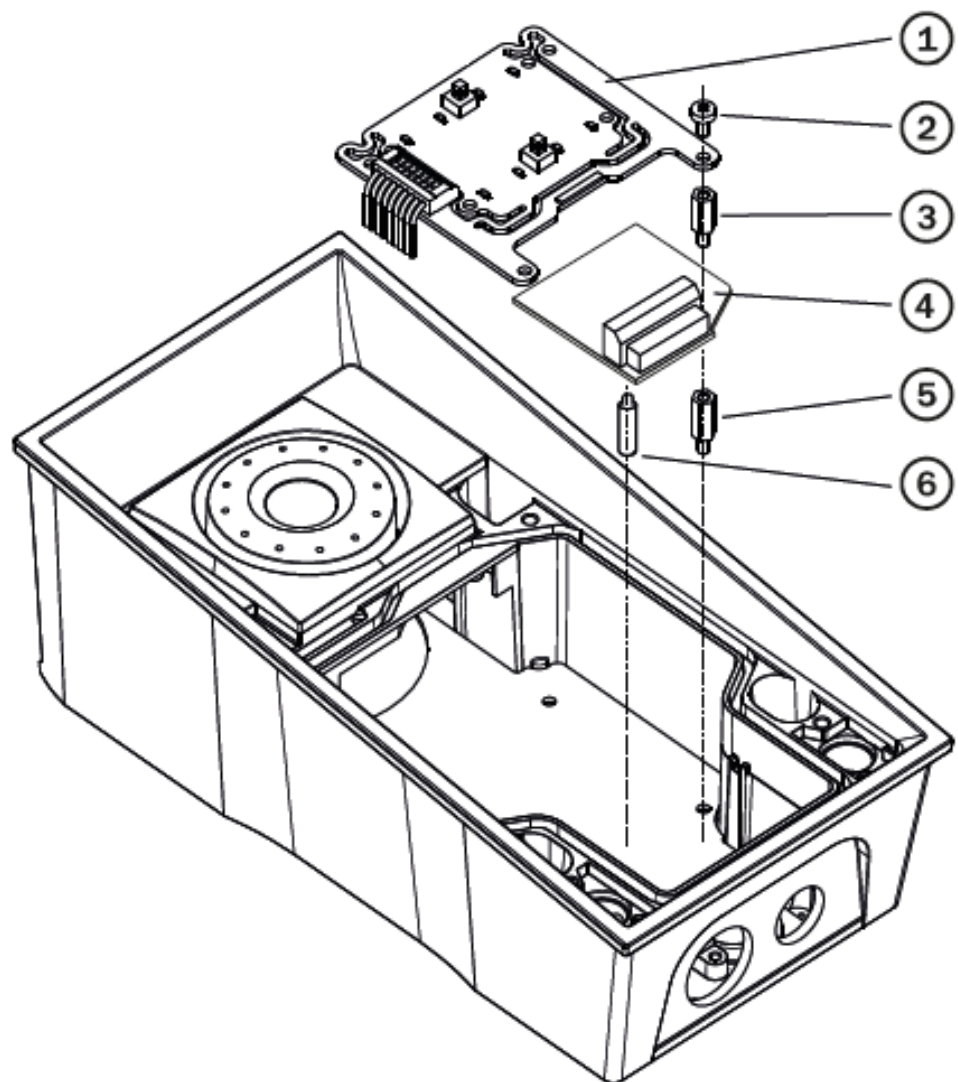



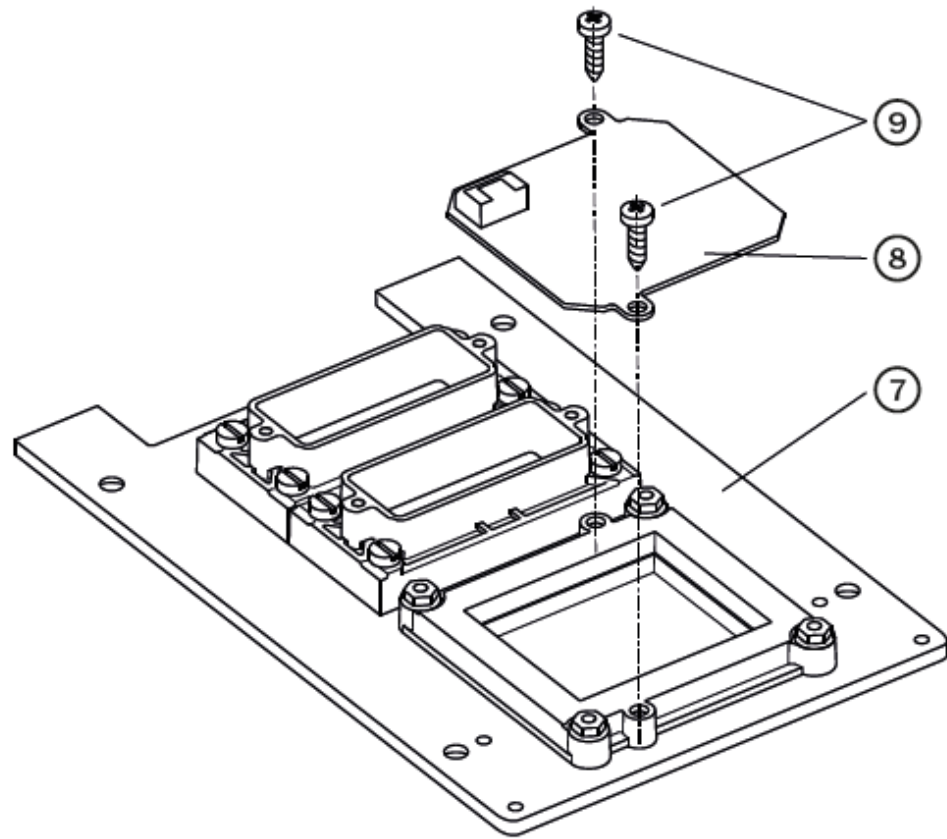

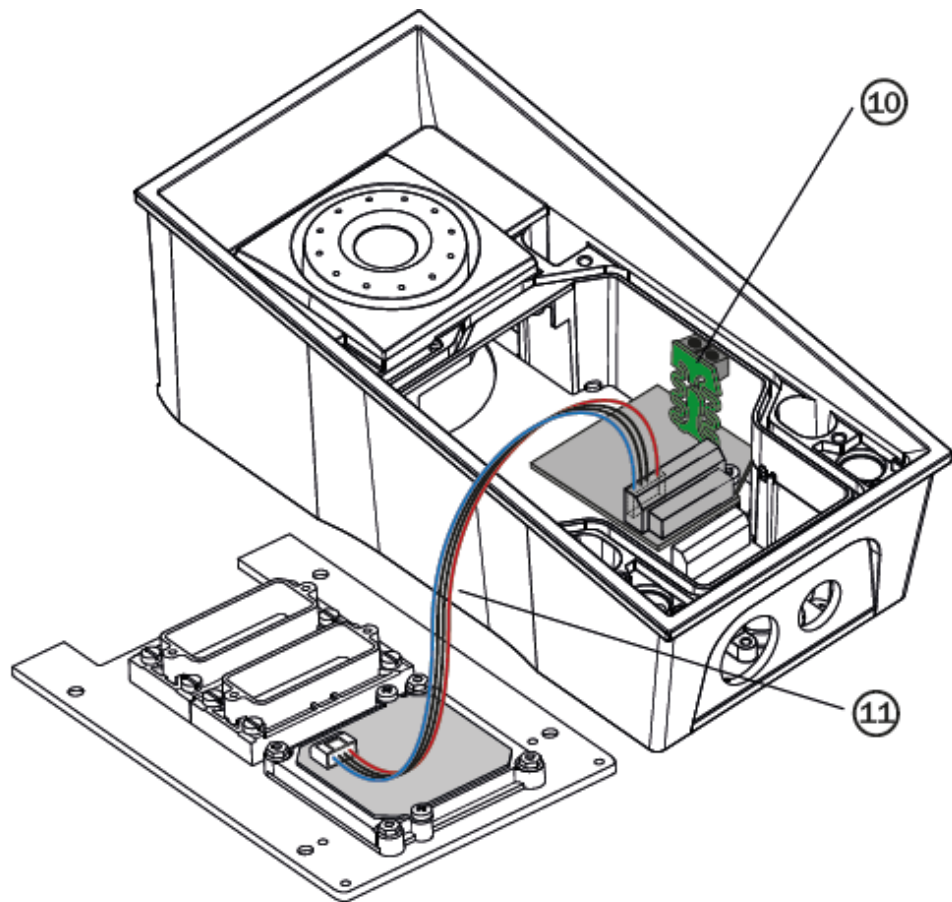

**Module setting:**

Refer to the **2N® Helios IP Configuration Manual** for details of Wiegand, outputs and reader. Refer to the **2N® Helios IP Automation manual** for details of input, red LED and tamper function and use.

**Connection:**

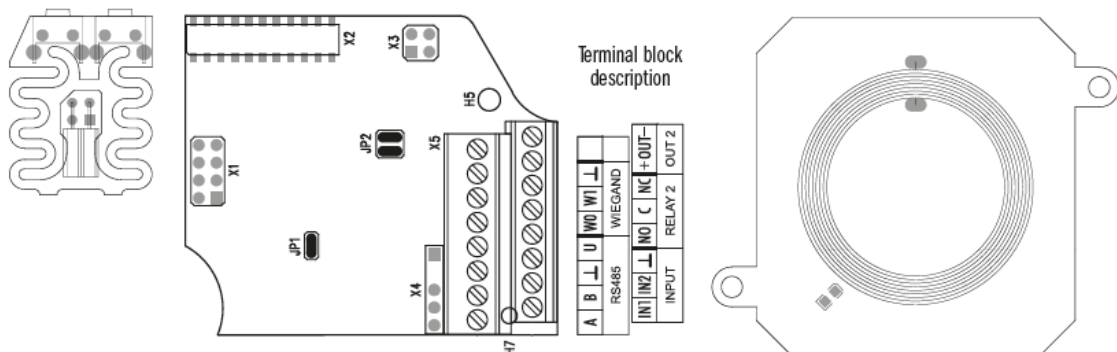

## Internal RFID Card Reader 13.56 MHz

The **Internal RFID Card Reader 13.56 MHz** (Part No. 9151016) is used for reading RFID card Ids in the 13.56 MHz band. This module is intended for mounting into the **2N® Helios IP Force** model 9151102CR, 9151102R, 9151101CRP and 9151101RP. These models have an window, which is necessary for antenna operation. If the Internal RFID Card Reader is installed, it is not possible to install the Additional Switch.

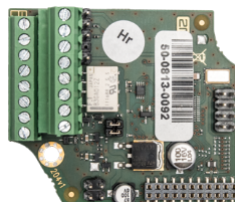

### Function:

The **2N® Helios IP Force** Internal RFID Card Reader adds two logical inputs, two additional switches and a tamper switch to the **2N® Helios IP Force** basic unit.

The purpose of the tamper switch is to signal any unauthorised opening of the intercom (to prevent a theft, e.g.). It is recommended to use the tamper switch.

#### ✓ Tip

- FAQ: [Tamper switch - How to install it into the 2N® Helios IP Force](#)

### Specifications:

#### Card reader

- Operating frequency: 13.56 MHz
- Minimum reading distance: 30 mm above **2N® Helios IP Force** cover
- Compatible with cards
  - **ISO14443A** - Mifare Classic 1k & 4k, DESFire EV1, Mini, Plus S&X, SmartMX, Ultralight, Ultralight C, SLE44R35, my-d move (SLE66Rxx), PayPass, Legic Advant
  - **ISO1443B** - Calypso, CEPAS, Moneo, SRI512, SRT512, SRI4K, SRIX4K, PicoPass, HID iCLASS
  - **ISO18092/NFC** - NFCIP-1: Active and passive communication mode, NFC Forum Tag Type 1-4, Sony FeliCa

#### Relay output

- Switching contact
- 30 V / 2A AC/DC

### Active output

- 9 to 12 V / 700 mA transistor switched output. Depends on power supply (PoE: 9 V or power supply voltage minus 1 V).

### Logical inputs

Active mode – requires external voltage (JP2 jumper OFF)

- $U_{IN-ON} = \min +2.5 \text{ V}$
- $U_{IN-OFF} = \max +1.5 \text{ V}$
- $U_{IN \max} = +48 \text{ V}$
- $I_{IN} (U_{IN} +48 \text{ V}) = \max 1 \text{ mA}$

Passive mode – requires external contact only (JP2 jumper ON)

- $U_{IN1} = \text{approx. } 8.3 \text{ V}$
- $U_{IN2} = \text{approx. } 8.3 \text{ V}$
- $I_{LOOP} = \text{approx. } 0.5 \text{ mA}$

### Signalling output

- Internal red LED under reader window

### PWR

- For external RFID card reader
- Out: 9 to 12 V / 350 mA depends on power supply

### WIEGAND interface

- Off/Input/Output (as programmed)

## Mounting guide:

1. Switch off the intercom.
2. Remove the front panel (7) from the intercom.
3. Mount antenna board (8). Use two enclosed self tapping screws (9).
4. Plug enclosed cable (11) to the antenna board connector.
5. Demount a button PCB (1). Don't disconnect its cable!
6. There will stay four spacers after the switch board removal. Dismount the bottom right one.
7. There are two short metal spacers enclosed to the reader. Take a longer one (5), 12 mm long. Screw it into the free hole.
8. Plug an enclosed plastic support (6) to the reader board from the bottom side.
9. Put the reader board (4) in the main board connector making sure that the mounting hole is directly above the spacer.
10. Screw in a remaining metal spacer (3), 10.5 mm long.
11. Fit the button PCB (1) back to its position using original bolts (2).
12. If you want to use the tamper switch (to detect unauthorized opening the case, as a theft protection), insert the tamper board (10) in the connector located in the right-hand bottom part of the reader board (4). As the tamper switch shares the relay output (NO and NC) terminals, you cannot use the RELAY2 output with the tamper switch at the same time.
13. Plug the antenna cable (11) to its connector at the reader board (4).
14. Place front panel back and tighten all four screws.



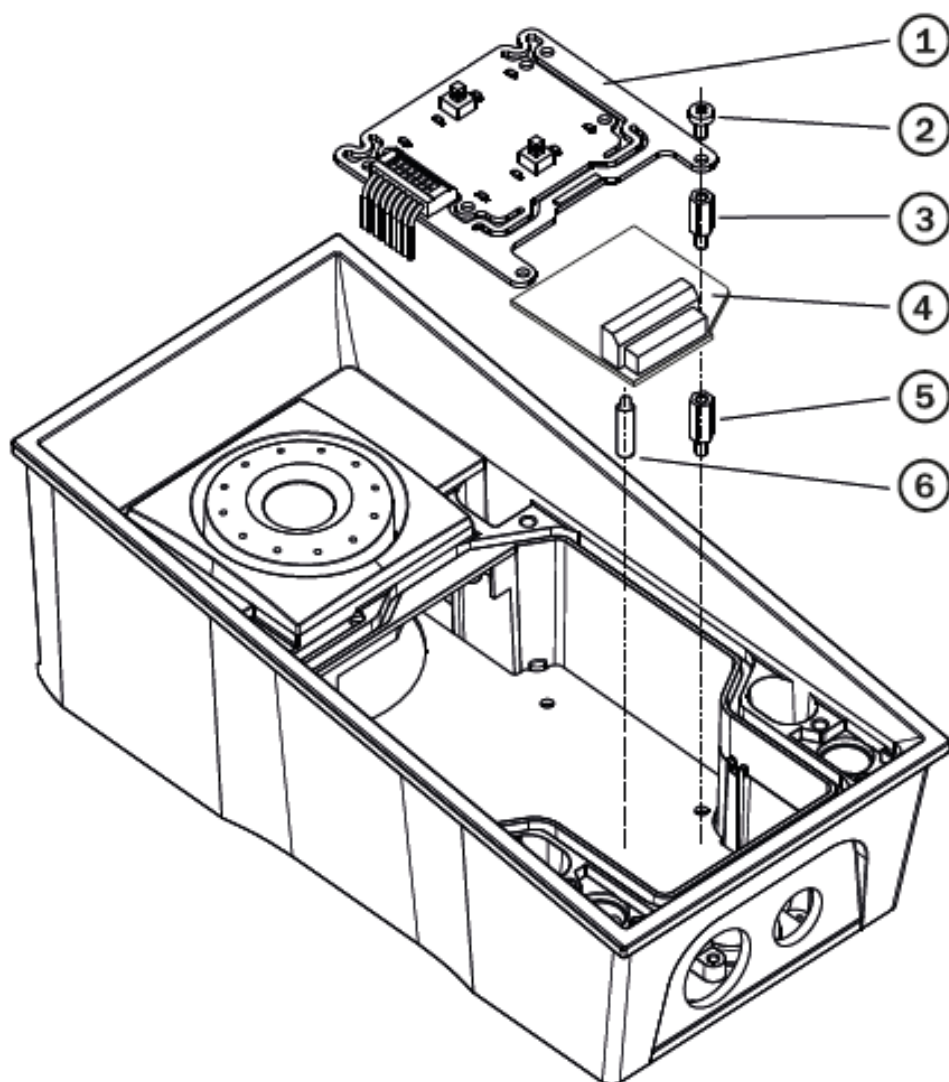



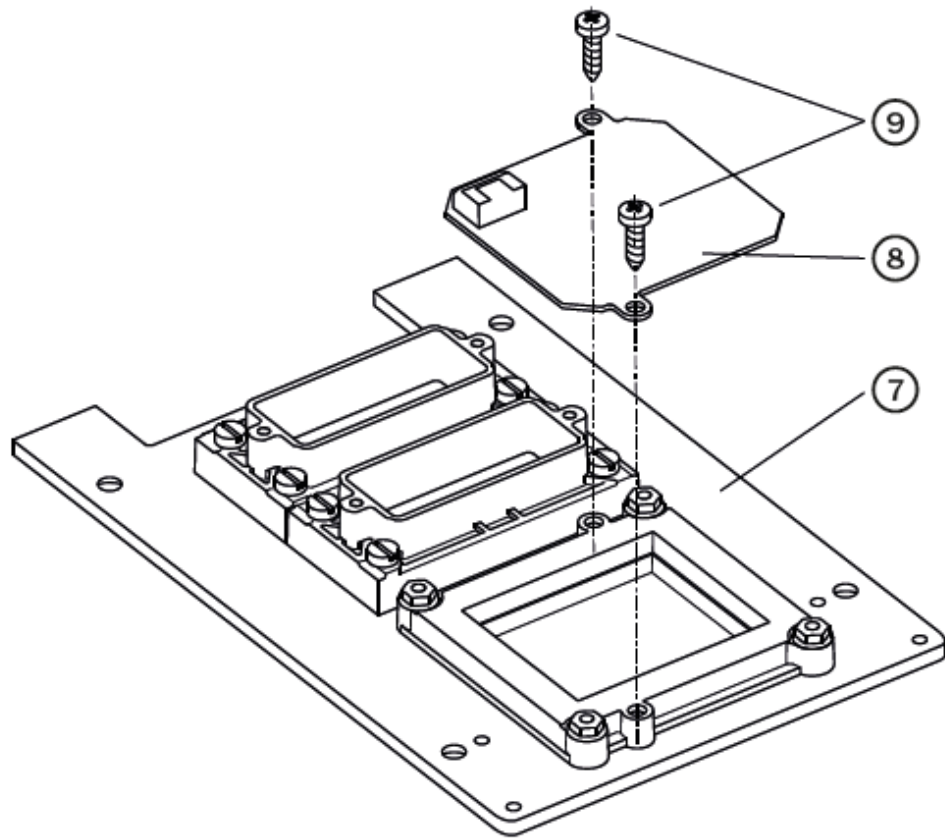



## Security Relay

---

The **Security Relay** (Part No. 9159010) is used for enhancing security between the intercom and the connected electric lock. The **2N® Helios IP Security Relay** is designed for any **2N® Helios IP** intercom model with firmware versions 1.15 and higher. It significantly enhances security of the connected electric lock as it prevents lock opening by forced intercom tampering.



### Function:

The **2N® Helios IP Security Relay** is a device installed between an intercom (outside the secured area) and the electric lock (inside the secured area). The **2N® Helios IP Security Relay** includes a relay that can only be activated if the valid opening code is received from the intercom.

### Specifications:

- Passive switch: NO and NC contacts, up to 30 V / 1 A AC/DC
- Active switch output: 9 to 12 V / 700 mA transistor switched output. Depends on power supply (PoE: 9 V or power supply voltage minus 1 V).
- Dimensions: (56 × 31 × 24) mm
- Weight: 20 g

### Installation:

Install the **2N® Helios IP Security Relay** onto a two-wire cable between the intercom and the electric lock inside the area to be secured (typically behind the door). The device is powered and controlled via this two-wire cable and so can be added to an existing installation. Thanks to its compact dimensions, the device can be installed into a standard mounting box.

### Connection:

Connect the **2N® Helios IP Security Relay** to the intercom as follows:

- To the intercom active output (OUT1 or OUT2) , or
- To the intercom relay output with a 12 V DC serial external power supply.

Connect the electric lock to the **2N® Helios IP Security Relay** output as follows:

- To the active 12 V / 700 mA DC output, or
- To the relay output with a serial external power supply.

The device also supports a Departure button connected between the 'PB' and '-HeliosIP' terminals. Press the Departure button to activate the output for 5 seconds.

### Status signalling:

Green LED	Red LED	Status
blinking	off	Operational mode
on	off	Activated output
blinking	blinking	Programming mode – waiting for initialisation
on	blinking	Error - wrong code received

### Configuration:

- Connect the **2N® Helios IP Security Relay** to the properly set intercom switch output; refer to the **2N® Helios IP Configuration Manual**. Make sure that one LED at least on the **2N® Helios IP Security Relay** is on or blinking.
- Press and hold the **2N® Helios IP Security Relay** Reset button for 5 seconds to put the device in the programming mode (both the red and green LEDs are blinking).
- Activate the intercom switch using the keypad, telephone, etc. The first code sent from the intercom will be stored in the memory and considered valid. After code initialisation, the **2N® Helios IP Security Relay** will pass into the operational mode (the green LED is blinking).

#### ✓ Tip

- FAQ: [2N® Helios IP Security Relay – what it is and how to use it with 2N® Helios IP intercom?](#)

#### ✓ Tip

- Video Tutorial: [Door intercoms 2N® Helios IP - Security Relay](#)

## Connection:

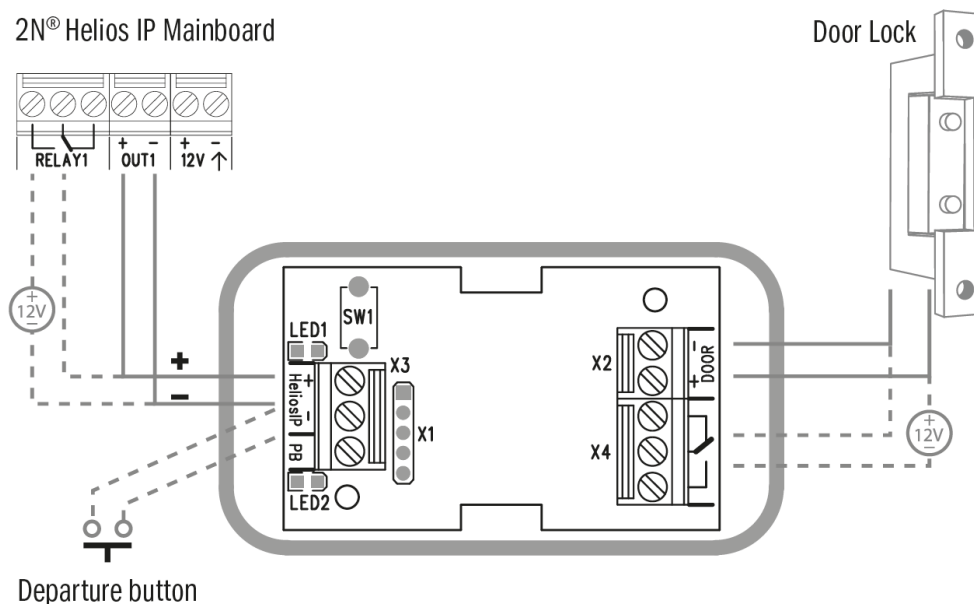

## Wiegand Isolator

The **Wiegand Isolator** (Part No. 9159011) is used for galvanic isolation of the Wiegand bus.

The **2N® Helios IP Wiegand Isolator** is designed for galvanic isolation of two devices with separate power supply and interconnected via the Wiegand bus. The **2N® Helios IP Wiegand Isolator** protects the interconnected devices against communication errors and/or damage.

Connection of the **2N® Helios IP Card Reader** to a security system unit is a typical example of application.



## Function:

The **2N® Helios IP Wiegand Isolator** separates galvanically a two-wire Wiegand bus in one direction and a status LED signal in the other direction. The module is power supplied from the Wiegand bus receiver side.

## Specifications:

- 2-wire WIEGAND IN
- 2-wire WIEGAND OUT
- LED IN switched against GND on WIEGAND OUT side
- Open LED OUT switched against GND on WIEGAND IN side (up to 24 V / 50 mA)
- 5 to 16V / 10 mA power supply from Wiegand bus receiver side
- 500 V DC isolation strength

## Connection:

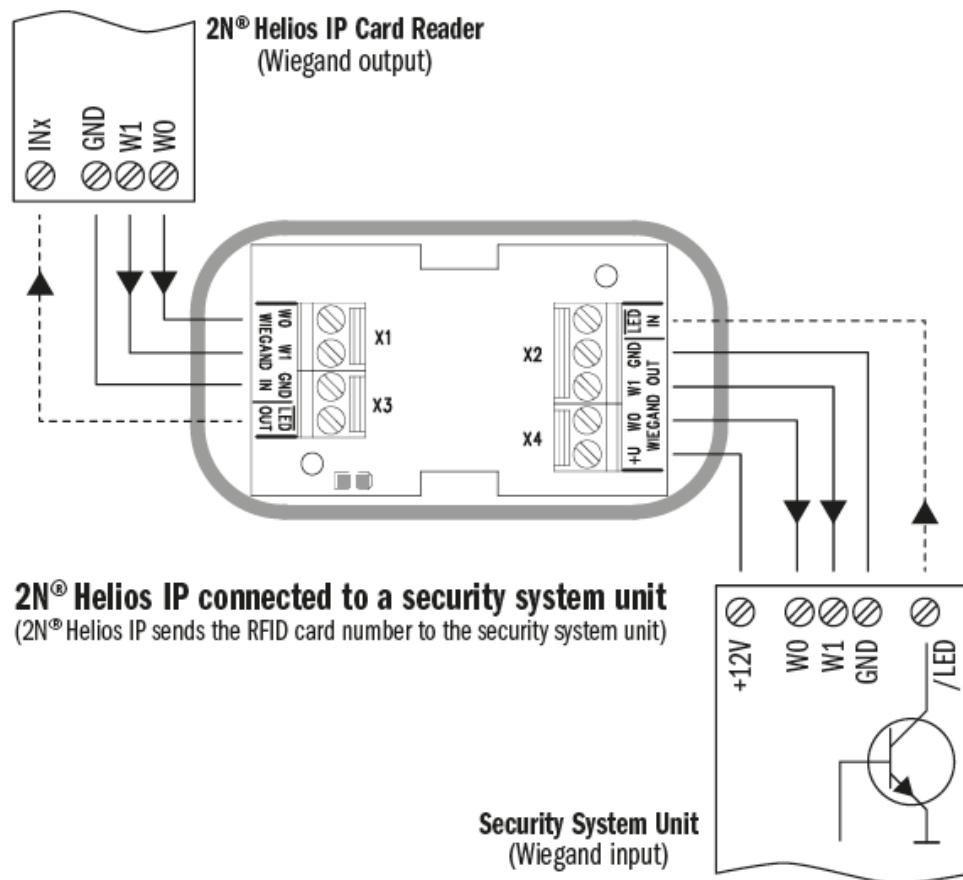



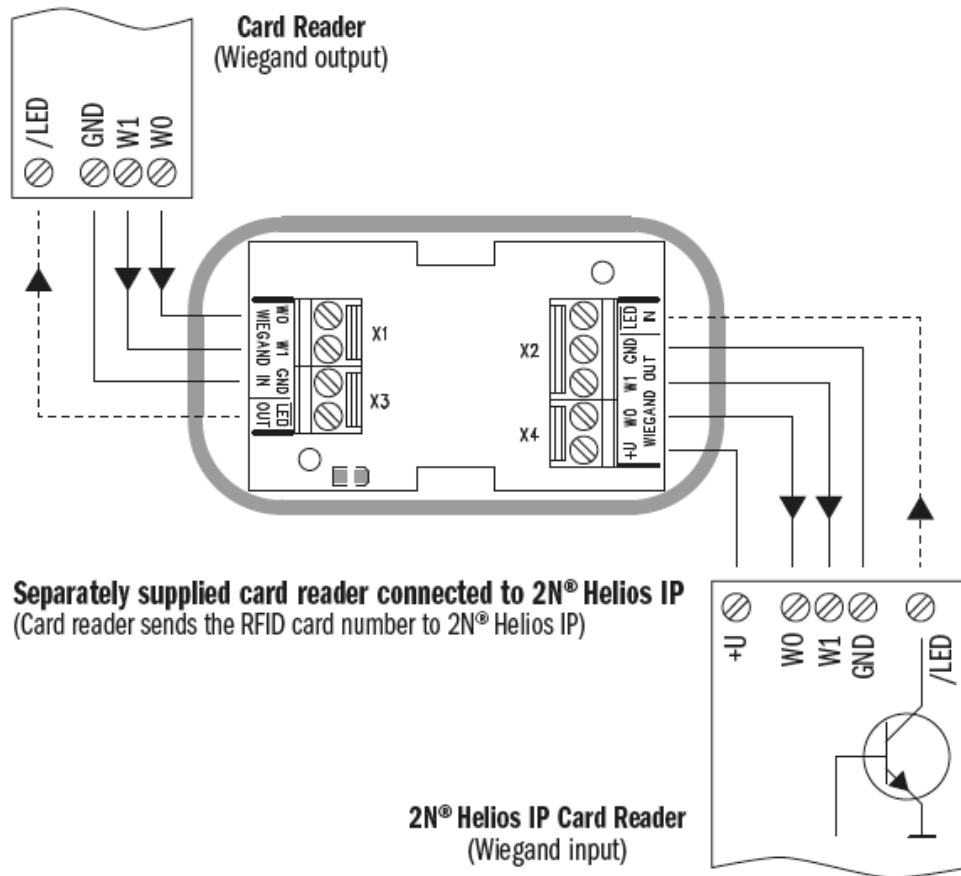

## 2.5 Button Tags

This subsection describes work with Button Tags in **2N® Helios IP Force** .

### Tag Printing

1. Every **2N® Helios IP Force** delivery includes a sheet of translucent foil, which can be laser-printed. Cut the printed foil and insert the tags in the name plates.
2. Every name plate includes a piece of foil, which can be written over manually, using a waterproof permanent marker, if necessary.

#### Note

- Always use waterproof foil (enclosed or other) for the tags. Never use paper or ink jet printing to avoid damage due to water leakage!

#### Tip

- A template for printing nametags can be downloaded from [www.2n.cz](http://www.2n.cz).

### Tag Inserting/Replacing Instructions

**2N® Helios IP Force** provides an intuitive, easy access to the name plates. The tags are easy to insert and replace even without a manual. You need not remove the front panel and thus are not exposed to the risk of loss of components while replacing the tags.

1. Loosen the name plate screw using the wrench enclosed, for example. You can open the name plate window like a door without losing the tightened screw.
2. Remove the used or blank name tag and insert a new tag.
3. Close the name plate window and tighten the screw appropriately.
4. Check the click effect of the buttons: if the button fails to click properly when pressed (when moved by approx. 0.5 mm), the tag is too thick or thin. Make sure that the button clicks when you press it on both ends.



---

## 3. Function and Use

---

In this section we describe the basic and extending functions of the **2N<sup>®</sup> Helios IP Force** product.

Here is what you can find in this section:

- [3.1 Configuration](#)
- [3.2 Control](#)
- [3.3 Maintenance](#)

## 3.1 Configuration

Use a PC equipped with any web browser to configure **2N® Helios IP Force** :

- Launch your web browser (Internet Explorer, Firefox, etc.).
- Enter the IP address of your intercom (<http://192.168.1.100/>, e.g.).
- Log in using the **Admin** user name and **2n** password.

You have to know the IP address of your device to log in to the integrated web server. By default, **2N® Helios IP Force** is switched into the dynamic IP address mode, i.e. it obtains the IP address automatically if a properly set DHCP server is available in your LAN. If no such DHCP server is available, you can operate **2N® Helios IP Force** in the static IP address mode.

If your device remains inaccessible (you have forgotten the IP address, or the LAN configuration has changed, for example), change the LAN settings using the buttons on the device.

### IP Address Retrieval

Take the following steps to retrieve the **2N® Helios IP Force** IP address:

- Connect (or, if connected, disconnect and reconnect) **2N® Helios IP Force** to the power supply.
- Wait for the second sound signal .
- Press the first quick dial button 5 times.
- **2N® Helios IP Force** will read its IP address.
- If the address is 0.0.0.0, it means that the intercom has not obtained the IP address from the DHCP server.



#### Note

- Be sure to press the button sequence within thirty seconds after the sound signal for security reasons. Up to 2 s intervals are allowed between the presses.

## Static IP Address Setting for 4-button models

Follow the instructions below to enable the static IP address mode:

- Connect **2N® Helios IP Force** to the power supply (or, disconnect and reconnect it if already connected).
- Wait for the first acoustic signal .
- Press buttons 1, 1, 1, 2, 2, 3 sequentially.

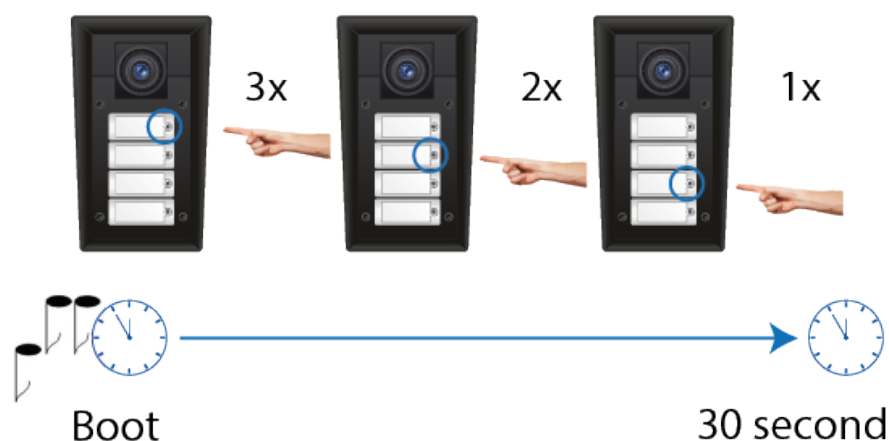

- The acoustic signal  indicates mode switching.
- Wait until the device is restarted automatically.

### Caution

- The 1, 1, 1, 2, 2, 3 sequence must be entered within 30 seconds after the first sound signal for security reasons. The inter-digit delay may be 2 s at most.

The device will have the following network parameters after restart:

- IP address – 192.168.1.100
- Network mask – 255.255.255.0
- Default gateway – 192.168.1.1

## Dynamic IP Address Setting for 4-button models

Follow the instructions below to enable automatic getting of network parameters from the DHCP server:

- Connect **2N® Helios IP Force** to the power supply (or, disconnect and reconnect it if already connected).
- Wait for the first acoustic signal .
- Press buttons 2, 1, 1, 2, 2, 3 sequentially.

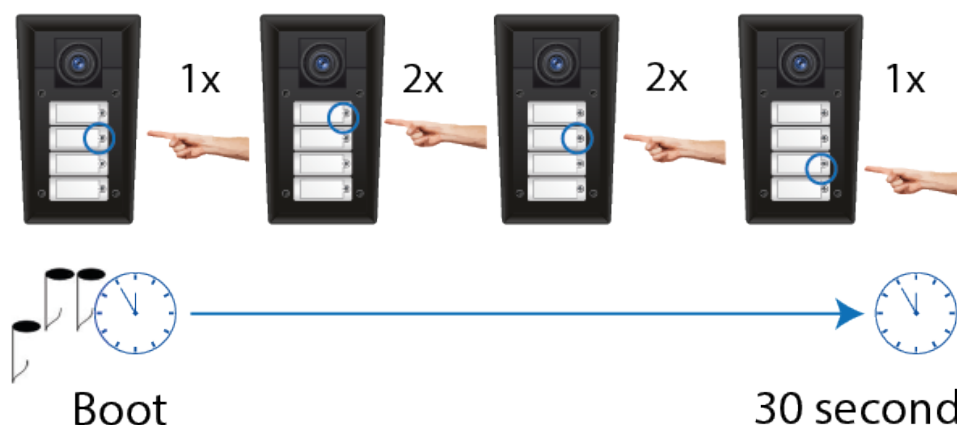

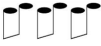
- The acoustic signal  indicates mode switching.
- Wait until the device is restarted automatically.



#### **Caution**

- The 2, 1, 1, 2, 2, 3 sequence must be entered within 30 seconds after the first sound signal for security reasons. The inter-digit delay may be 2 s at most.

**2N® Helios IP Force** gets the IP address upon restart only if the DHCP server is configured properly.

## Mode Switching with 1 or 2-Button Models

In case your **2N® Helios IP Force** device is equipped with 1 or 2 buttons, you can switch the modes using one button only.

- Connect **2N® Helios IP Force** to the power supply (or, disconnect and reconnect it if already connected).
- Wait for the first acoustic signal .
- Press the first quick dial button 15 times.
- The acoustic signal  indicates mode switching.
- Wait until the device is restarted automatically.



**⚠ Caution**

- The 15 times 1 sequence must be entered within 30 seconds after the first sound signal for security reasons. The inter-digit delay may be 2 s at most.

The static IP address mode will be switched into the dynamic IP address mode and vice versa upon restart.

## 3.2 Control

This subsection describes how to control **2N® Helios IP Force** when viewed by an external user.

### Speed Dial Buttons

---

Press the speed dial buttons on the basic unit to make quick dialling for the first 1, 2 or 4 positions (depending on the model type) in the telephone directory. Call setup is signalled by a long intermittent tone or otherwise as configured in the PBX connected.

Repeated pressing of one and the same speed dial button during call setup may initiate call termination, or call termination plus dialling the next telephone number of the called subscriber, or may be assigned no function. This behaviour can be set in unit configuration.



If your model is equipped with a numerical keypad, you can also push the  button anytime to terminate a call if enabled so in the **Hang up with #** parameter.

### Calling to Telephone Directory Positions

---

The **2N® Helios IP Force** telephone directory can contain up to 1999 pre-programmed positions. Speed dial can only be used for positions 1 to 4. The remaining positions can be retrieved via the numerical keypad if the **Speed dial using digits** function is enabled in configuration.

#### Procedure:



- Enter the position number using your numerical keypad (05, 15, 200, 1759 e.g. – two digits at least and four digits at most) and press  for confirmation.
- You can also push the  button anytime to terminate a call if enabled so in the **Hang up with #** parameter in the unit configuration.

### Calling to Telephone Number

---

You can dial a telephone number using your numerical keypad from **2N® Helios IP Force** if the **Enable telephone function** parameter is on.



#### Procedure:

1. Press the  button.
2. You will hear the continuous tone from the loudspeaker.
3. Enter the telephone number using the numerical keypad and repress  for confirmation.
4. You can also push the  button anytime to terminate a call if enabled so in the **Hang up with #** parameter; refer to the Miscellaneous subsection.



## Answering and Rejecting Incoming Calls

---



If the automatic incoming call answering function is off, **2N® Helios IP Force** signals an incoming call with loud ringing. Push the  button to answer the call and the  to reject the call. This function is available in models equipped with a numerical keypad only.

## Door Opening (Switch Activation) by Code

---

**2N® Helios IP Force** is equipped with a door lock opening switch. Enter the valid code using your numerical keypad to activate the switch.

### Procedure:







- Enter the numerical switch activating code using the numerical keypad and press  for confirmation.
- A successful entering of a valid code is signalled by a continuous tone indicating unlocking (switch activation). An invalid code is signalled acoustically by .

## User/Profile Activation and Deactivation

---

Activate/deactivate a user or a profile using the numerical keypad in order to define call routing to the telephone directory numbers more specifically.

### Procedure:

- Enter the numerical user activating/deactivating code and press  for confirmation.
- A successful entering of a valid code is signalled acoustically by  (  for profile) for activation, or  (  for profile) for deactivation. An invalid code is signalled acoustically by .

## 3.3 Maintenance

### Cleaning

---

If used frequently, **2N® Helios IP Force** gets dirty. To clean it, use a piece of soft cloth moistened with clean water. We recommend you to obey the following principles while cleaning:

- Never use aggressive detergents (such as abrasives or strong disinfectants).
- Use suitable cleaning agents for glass lens cleaning (cleaners for glasses, optic devices screens, etc.).
- Alcohol-based cleaners may be applied.
- Clean the device in dry weather in order to make waste water evaporate quickly.

 **Tip**

- The **2N® Helios IP Force** models of Part Nos. 9151101**W** and 9151101**C** **W** may be cleaned with WAP high pressure washers.

### Future Tag Replacement, Programming Changes

---

For necessary steps refer to the preceding subsections. Keep the following for future changes:

- This manual
- Unused transparent foil strips for button tags

 **Caution**

- Always use the product for the purpose it was designed and manufactured for, in compliance herewith.
- The manufacturer reserves the right to modify the product in order to improve its qualities.
- **2N® Helios IP Force** contains no environmentally harmful components. When the product's service life is exhausted and you would like to dispose of it please do so in accordance with applicable legal regulations.

# 4. Technical Parameters

---

## Signalling protocol

---

- **SIP (UDP, TCP, TLS)**

## Buttons

---

- **Button design:** Transparent, white backlit buttons with easily replaceable name tags
- **Count of buttons:** 1, 2 or 4
- **Numerical keypad:** optional

## Audio

---

- **Microphone:** 2 integrated microphones
- **Amplifier:** 10 W (class D)
- **Loudspeaker:** 1 W (optionally 10 W)
- **Volume control:** Adjustable with automatic adaptive mode
- **Full duplex:** Yes (AEC)

## Audio stream

---

- **Protocols:** RTP / RTSP
- **Codecs:** G.711, G.729, G.722, L16/16kHz

## Camera

- **Sensor:** 1/4" colour CMOS
- **Resolution:** 640 (H) × 480 (V)
- **Picture frequency:** Up to 30 snaps/s
- **Sensitivity:** 1.9 V/lux-sec (550 nm)
- **Viewing angle:** 135° (H), 109° (V)
- **Infrared illumination:** Yes
- **Focal length:** 1.1 mm
- **Focal length HD version:** 2.3 mm

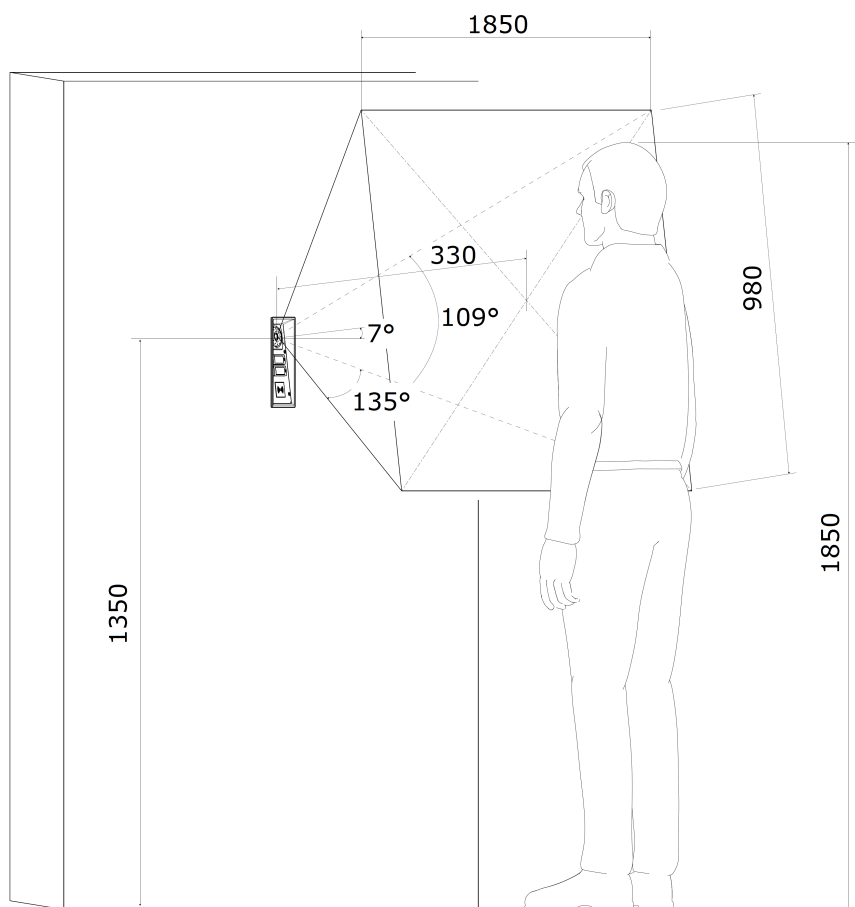

## Video stream

- **Protocols:** RTP / RTSP / HTTP
- **Codecs:** H.263, H.263+, H.264, MPEG-4, M-JPEG
- **IP camera function:** Yes

## Interface

---

- **Power supply:** 12 V  $\pm$ 15 % / 2 A DC or PoE
- **PoE:** PoE 802.3af (Class 0 - 12.95 W)
- **LAN:** 10/100BASE-TX s Auto-MDIX, RJ-45
- **Recommended cabling:** Cat-5e or higher
- **Passive relay switch:** NO and NC contacts, up to 30 V / 1 A AC/DC
- **Active switch output:** 9 up to 13 V DC depending on power supply (PoE: 9 V; adaptor: power supply voltage minus 1 V), max 700 mA

## RFID card reader

---

- **Optional**
  - Includes besides card reader itself: Wiegand interface, tamper switch, active output, relay, two inputs
- **Supported cards on 125 kHz version, Part No. 9151011**
  - EM4100, EM4102, HID Prox
- **Supported cards on 13.56 MHz version, Part No. 9151016** (only card serial number is read)
  - ISO14443A
    - Mifare Classic 1k & 4k, DESFire EV1, Mini, Plus S&X, SmartMX, Ultralight,
    - Ultralight C, SLE44R35, my-d move (SLE66Rxx), PayPass, Legic Advant
  - ISO14443B
    - Calypso, CEPAS, Moneo, SRI512, SRT512, SRI4K, SRIX4K, PicoPass, HID iCLASS
- **Supported cards on 13.56 MHz NFC version, Part No. 9151017** (only card serial number is read)
  - ISO14443A
    - Mifare Classic 1k & 4k, DESFire EV1, Mini, Plus S&X, SmartMX, Ultralight,
    - Ultralight C, SLE44R35, my-d move (SLE66Rxx), PayPass, Legic Advant
  - ISO14443B
    - Calypso, CEPAS, Moneo, SRI512, SRT512, SRI4K, SRIX4K, PicoPass, HID iCLASS
  - NFC
    - SmartPhone with NFC/HCE support, since Android version 4.3
- **Wiegand Interface:** Input/Output mode, located on RFID card reader module
- **Active switch output:** 9 up to 13 V DC depending on power supply (PoE: 9 V; adaptor: power supply voltage minus 1 V), max 700 mA
- **Passive relay switch:** NO and NC contacts, up to 30 V / 1 A AC/DC

## Additional switch

---

- **Optional:** Includes also tamper switch
- **Active switch output:** 9 up to 13 V DC depending on power supply (PoE: 9 V; adaptor: power supply voltage minus 1 V), max 700 mA
- **Passive relay switch:** NO and NC contacts, up to 30 V / 1 A AC/DC

## Mechanical properties

---

- **Cover:** Robust aluminium cast product, front panel: aluminium cast, fiberglass FR4 (91511xxxR)
- **Working temperature:** –40 °C to 55 °C
- **Working relative humidity:** 10 % – 95 % (non-condensing)
- **Storing temperature:** –40 °C to 70 °C
- **Dimensions**
  - 217 × 109 × 83 mm
  - 242 × 136 × 83 mm incl. frame
- **Weight:** netto max. 2 kg / brutto max. 2,5 kg
- **Covering level:** IP65, IP69K (91511xxxW)

---

# 5. Supplementary Information

---

Here is what you can find in this section:

- [5.1 Troubleshooting](#)
- [5.2 Directives, Laws and Regulations](#)
- [5.3 General Instructions and Cautions](#)

## 5.1 Troubleshooting



For the most frequently asked questions refer to [faq.2n.cz](http://faq.2n.cz).



## 5.2 Directives, Laws and Regulations

### Europe

---

**2N® Helios IP Force** conforms to the following directives and regulations:

Directive 1999/5/EC of the European Parliament and of the Council, of 9 March 1999 – on radio equipment and telecommunications terminal equipment and the mutual recognition of their conformity

Directive 2006/95/EC of the European Parliament and of the Council of 12 December 2006 on the harmonisation of the laws of Member States relating to electrical equipment designed for use within certain voltage limits

Directive 2004/108/EC of the Council of 15 December 2004 on the harmonisation of the laws of Member States relating to electromagnetic compatibility

Commission Regulation (EC) No. 1275/2008, of 17 December 2008, implementing Directive 2005/32/EC of the European Parliament and of the Council with regard to ecodesign requirements for standby and off mode electric power consumption of electrical and electronic household and office equipment

Directive 2011/65/EU of the European Parliament and of the Council of 8 June 2011 on the restriction of the use of certain hazardous substances in electrical and electronic equipment

Regulation (EC) No. 1907/2006 of the European Parliament and of the Council of 18 December 2006 concerning the Registration, Evaluation, Authorisation and Restriction of Chemicals (REACH), establishing a European Chemicals Agency, amending Directive 1999/45/EC and repealing Council Regulation (EEC) No. 793/93 and Commission Regulation (EC) No. 1488/94 as well as Council Directive 76/769/EEC and Commission Directives 91/155/EEC, 93/67/EEC, 93/105/EC and 2000/21/EC

Directive 2012/19/EC of the European Parliament and of the Council of 4 July 2012 on waste electrical and electronic equipment.

### Industry Canada

---

This Class B digital apparatus complies with Canadian ICES-003. / Cet appareil numérique de la classe B est conforme à la norme NMB-003 du Canada.

## FCC

---

NOTE: This equipment has been tested and found to comply with the limits for a Class B digital device, pursuant to part 15 of the FCC Rules. These limits are designed to provide reasonable protection against harmful interference in a residential installation. This equipment generates, uses and can radiate radio frequency energy and, if not installed and used in accordance with the instructions, may cause harmful interference to radio communications. However, there is no guarantee that interference will not occur in a particular installation. If this equipment does cause harmful interference to radio or television reception, which can be determined by turning the equipment off and on, the user is encouraged to try to correct the interference by one or more of the following measures:

- Reorient or relocate the receiving antenna
- Increase the separation between the equipment and receiver
- Connect the equipment into an outlet on a circuit different from that to which the receiver is connected
- Consult the dealer or an experienced radio/TV technician for help.

Changes or modifications to this unit not expressly approved by the party responsible for compliance could void the user's authority to operate this equipment.

## 5.3 General Instructions and Cautions

Please read this User Manual carefully before using the product. Follow all instructions and recommendations included herein.

Any use of the product that is in contradiction with the instructions provided herein may result in malfunction, damage or destruction of the product.

The manufacturer shall not be liable and responsible for any damage incurred as a result of a use of the product other than that included herein, namely undue application and disobedience of the recommendations and warnings in contradiction herewith.

Any use or connection of the product other than those included herein shall be considered undue and the manufacturer shall not be liable for any consequences arisen as a result of such misconduct.

Moreover, the manufacturer shall not be liable for any damage or destruction of the product incurred as a result of misplacement, incompetent installation and/or undue operation and use of the product in contradiction herewith.

The manufacturer assumes no responsibility for any malfunction, damage or destruction of the product caused by incompetent replacement of parts or due to the use of reproduction parts or components.

The manufacturer shall not be liable and responsible for any loss or damage incurred as a result of a natural disaster or any other unfavourable natural condition.

The manufacturer shall not be held liable for any damage of the product arising during the shipping thereof.

The manufacturer shall not make any warrant with regard to data loss or damage.

The manufacturer shall not be liable and responsible for any direct or indirect damage incurred as a result of a use of the product in contradiction herewith or a failure of the product due to a use in contradiction herewith.

All applicable legal regulations concerning the product installation and use as well as provisions of technical standards on electric installations have to be obeyed. The manufacturer shall not be liable and responsible for damage or destruction of the product or damage incurred by the consumer in case the product is used and handled contrary to the said regulations and provisions.

The consumer shall, at its own expense, obtain software protection of the product. The manufacturer shall not be held liable and responsible for any damage incurred as a result of the use of deficient or substandard security software.

The consumer shall, without delay, change the access password for the product after installation. The manufacturer shall not be held liable or responsible for any damage incurred by the consumer in connection with the use of the original password.

The manufacturer also assumes no responsibility for additional costs incurred by the consumer as a result of making calls using a line with an increased tariff.

## Electric Waste and Used Battery Pack Handling

---



Do not place used electric devices and battery packs into municipal waste containers. An undue disposal thereof might impair the environment!

Deliver your expired electric appliances and battery packs removed from them to dedicated dumpsites or containers or give them back to the dealer or manufacturer for environmental-friendly disposal. The dealer or manufacturer shall take the product back free of charge and without requiring another purchase. Make sure that the devices to be disposed of are complete.

Do not throw battery packs into fire. Battery packs may not be taken into parts or short-circuited either.

**2N TELEKOMUNIKACE a.s.**

Modřanská 621, 143 01 Prague 4, Czech Republic

Phone: +420 261 301 500, Fax: +420 261 301 599

E-mail: [sales@2n.cz](mailto:sales@2n.cz)

Web: [www.2n.cz](http://www.2n.cz)

EN2065\_v2.0.3